

# Business Processes Modelling

## MPB (6 cfu, 295AA)

Roberto Bruni

<http://www.di.unipi.it/~bruni>

02 - Business processes

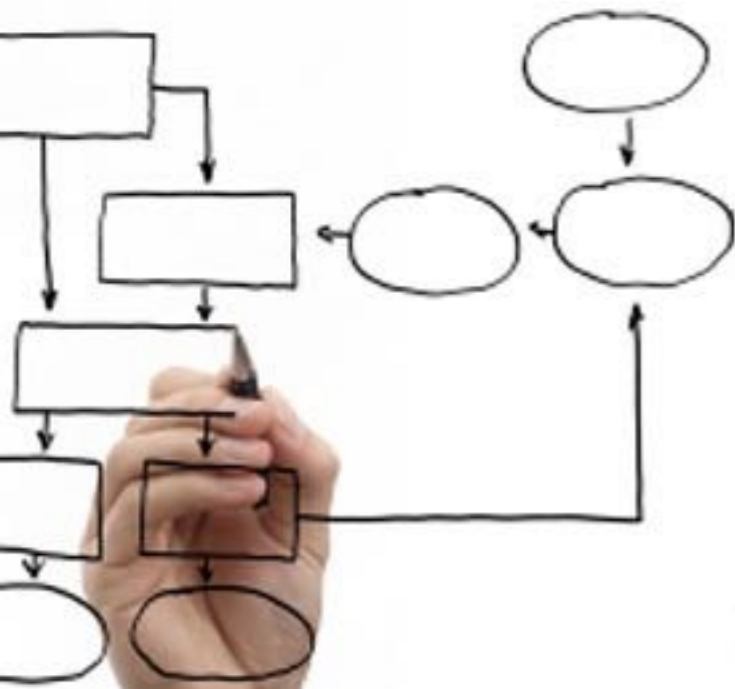

# Digression...

## Theorem

A (connected) graph  $G$  contains an **Eulerian circuit** if and only if there are no odd vertices.

## Theorem

A (connected) graph contains an **Eulerian path** if and only if there are 0 or 2 odd vertices.

# Digression...

Eu path  
no Eu circuit

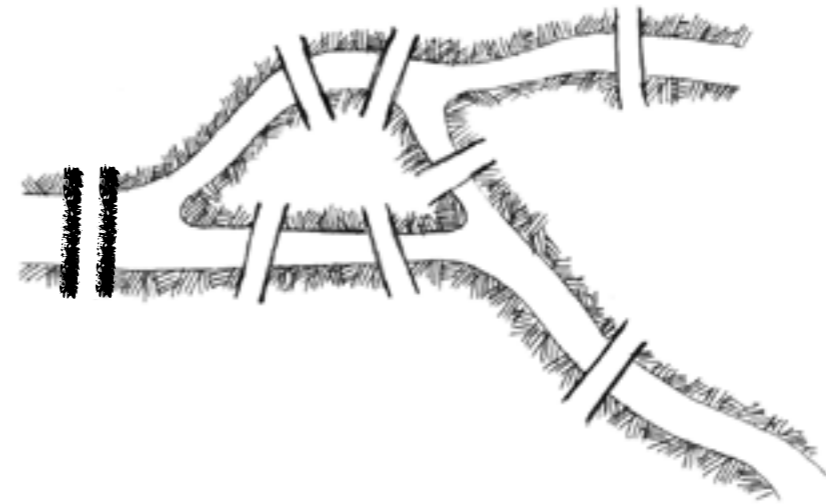
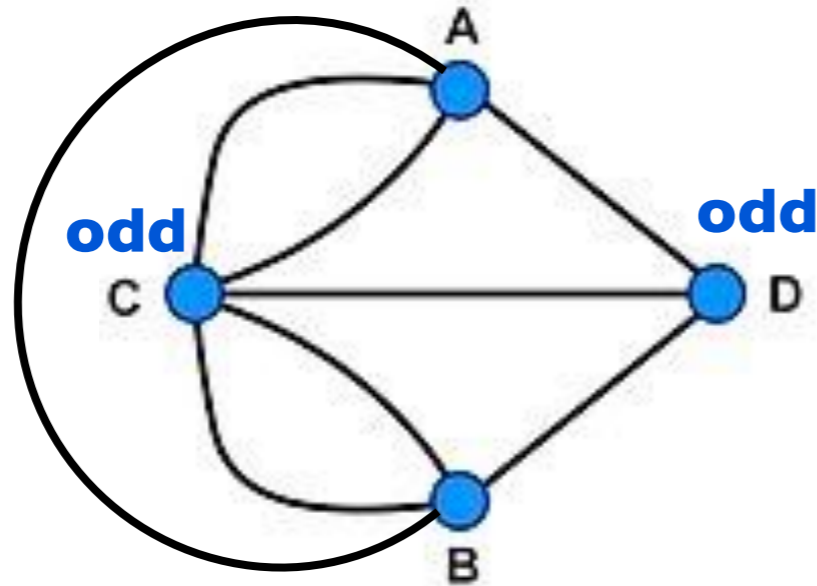

Eu path  
no Eu circuit

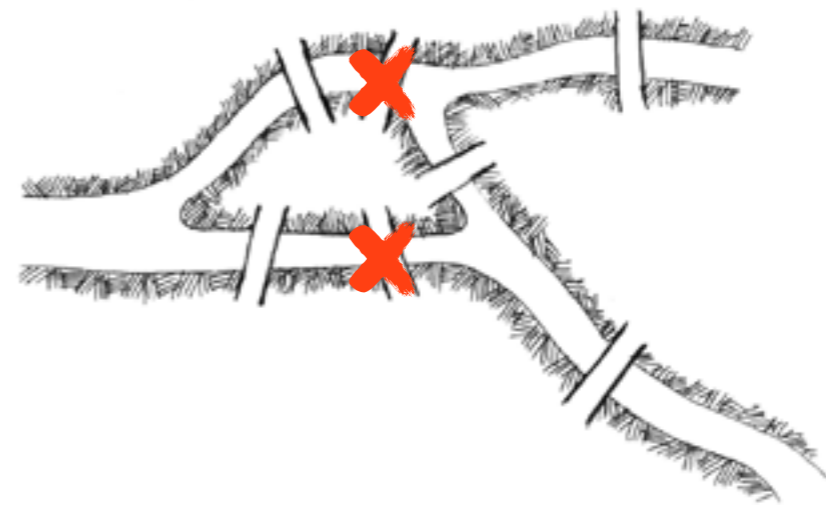
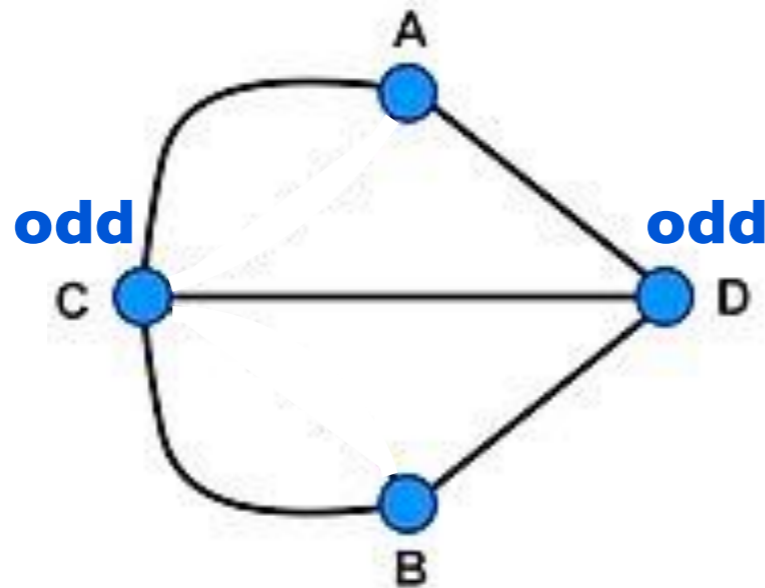

# Digression...

Eu path  
no Eu circuit

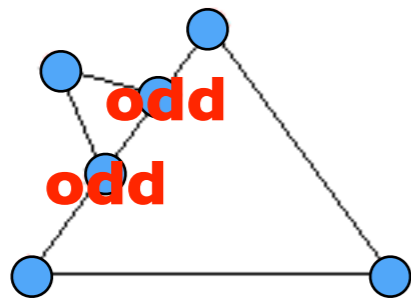

no Eu path  
no Eu circuit

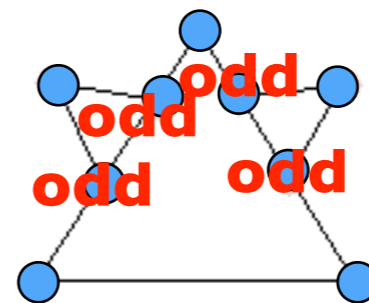

Eu path  
no Eu circuit

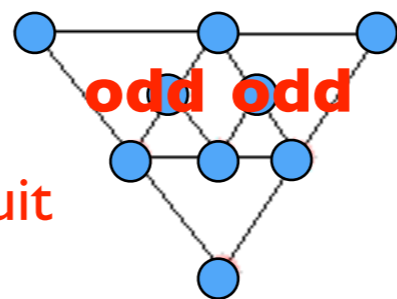

no Eu path  
no Eu circuit

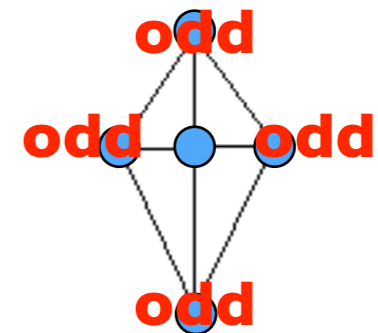

**Exercises:** find Eulerian path/circuits in the graphs above or prove that they cannot exist.

# Digression...

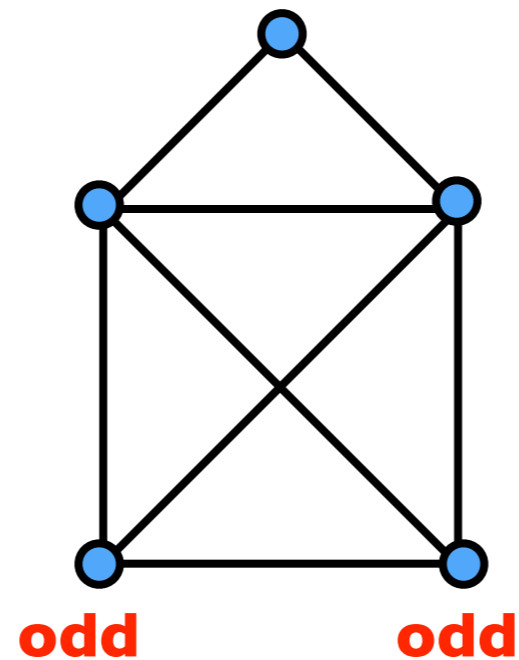

Eu path

no Eu circuit

A childish puzzle

# Digression...

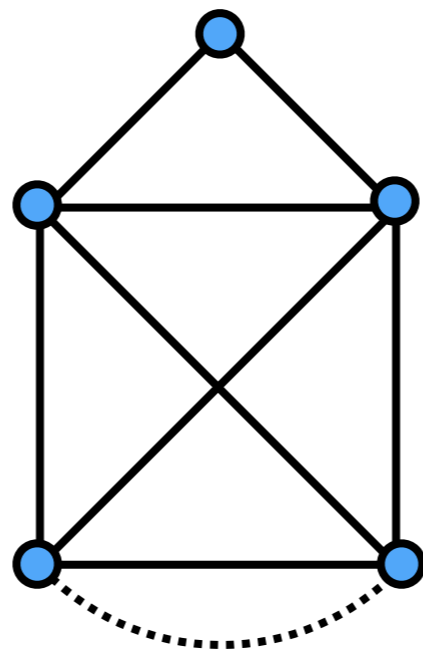

A childish puzzle

# Digression...

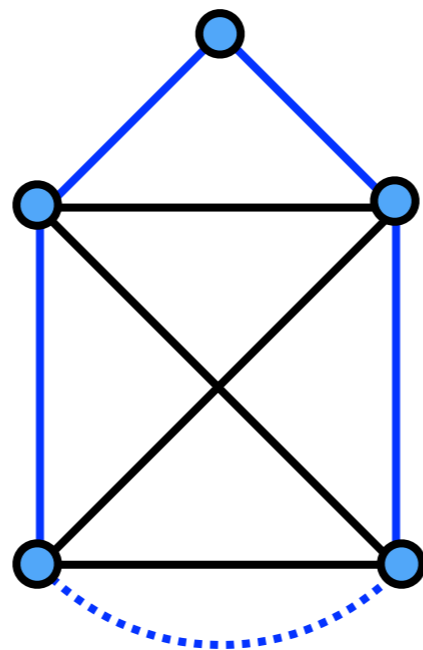

A childish puzzle

# Digression...

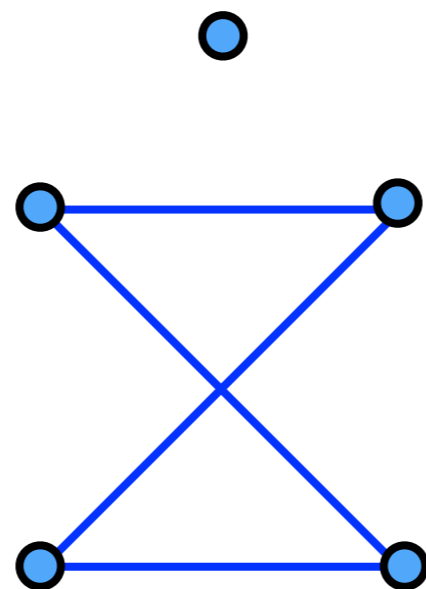

A childish puzzle



# Digression...

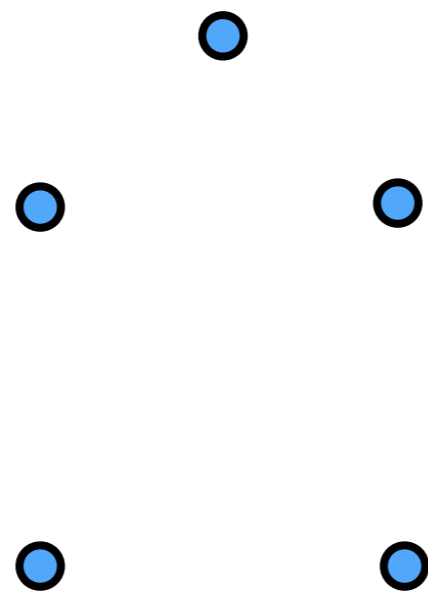

A childish puzzle

# Digression...

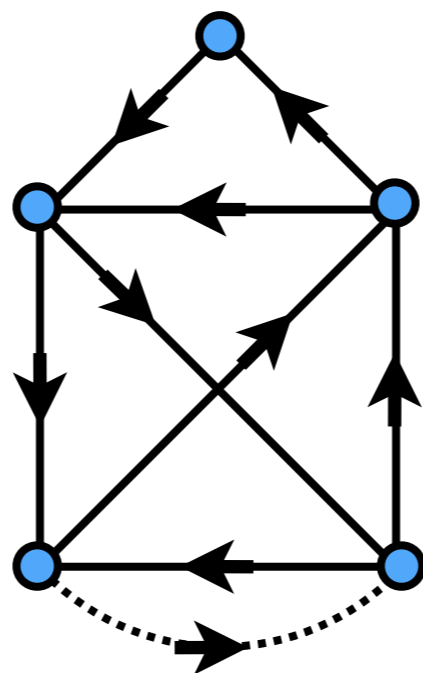

A childish puzzle

# Memo: Who are you?



Generale

Post

File

Background check (M...



## Background check (form)

Enrollment number: *123456*

Bachelor degree: *Comp. Sci., Pisa, IT*

MSc course of enrollment: *Data Science and BI*

Subjects of interest: *Data analysis, AI*

... :

Let's start

# Object: Terminology

Generic terms, widely applicable to different working situations and companies

We fix preferred terms when possible, but allow synonyms interchangeably

*Ch.1 of Workflow Management: Models, Methods, and Systems*

*Ch.1 of Business Process Management: Concepts, Languages, Architectures*

# Issues

- Process Orientation**
- Organizational structures
- Principal-contractor relationship
- Cases and procedures
- Process management

# Work

We need **products** to live our lives  
(food, clothing, house, transportation, fun, health)

Products are the outcome of some **work**

People work to live  
(or do we live to work?)

# Market

We are not capable to produce all we need  
(or all we want, or that we are induced to want)  
because we cannot be skilled enough

We buy products we cannot make ourselves

Products are supplied to people via markets  
(distribution in exchange of money)



# New services

Other work emerge, that would not exist  
(trading, banks, advertising, transportation,  
regulations, attorneys, insurance companies,  
eCommerce, eHealth, influencers, ...)

There are **services** and **products** necessary to  
keep the organization operating  
(not making a direct contribution to keep us alive)

# Business units

People organize specialized business units

They know how to do some specific product  
(limited range of products, highly efficient)

# Taylorism

Process orientation is based on a critical analysis of a concept to organize work units originally introduced by Frederick Taylor (1856-1915) to improve industrial efficiency

Taylorism uses functional breakdown of complex work to small granularities

Then, highly specialized work force can efficiently conduct these work units of small granularity

Taylorism has proved very successful in manufacturing and fuelled the industrial revolution

# Taylorism

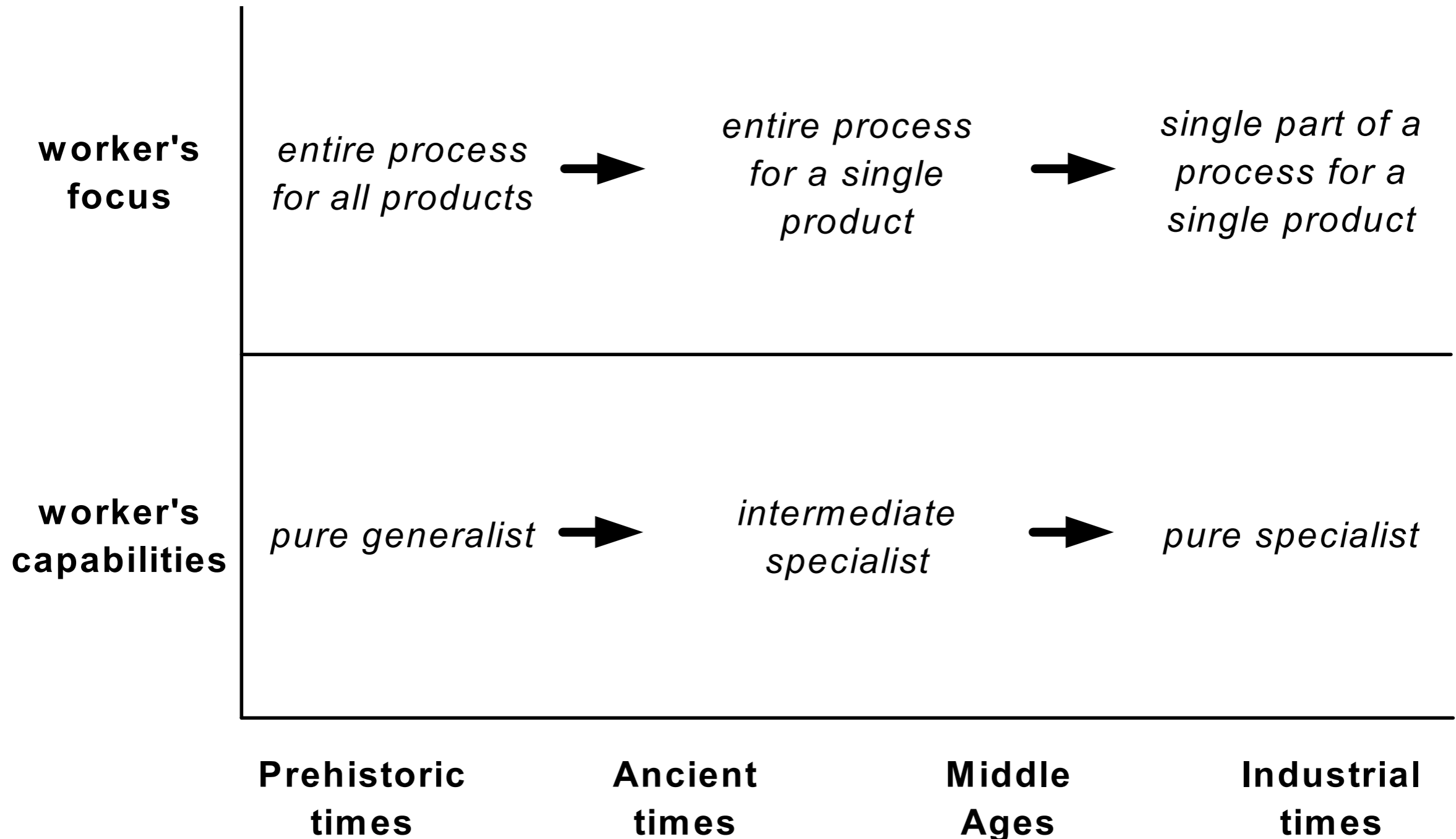

# Handovers

Fine-grained activities require many handovers of work in order to process a given task

Until early nineteenth century the products were typically assembled in a few steps only, so handovers were not introducing much delays

Moreover, tasks were of simple nature and did not require any context information on previously conducted steps

Taylorism proved inefficient for organizing work in modern enterprises

# Pitfall of Taylorism

Steps of a business process are often related to each other

Context information on the whole case is required during the process

The handovers of work cause a major problem because of that (workers required knowledge)

In the end, plain functional breakdown proved inefficient in modern business organizations that mainly process information

# Complexity

Modern society is too complex for people to see how their work fits in the overall scheme  
(alienation can become a major social problem)

The same scheme applies to large companies:  
high degree of work specialization  
cause the big picture to be lost by employees  
(why do they have to do the things they are told to do?)

# Process Orientation

Alienation from work can have negative effects on  
(human life and) productivity

Companies can allow employees to know  
they are working for a particular customer  
(increase motivation, self-esteem, productivity)

Not only process orientation serves  
to capture the activities a company performs, but also  
to **study** and **improve** the **relationships** between activities



# Process perspective

It is instrumental to combine multiple units of work of small granularity into work units of larger granularity to reduce the handover of work

As a consequence, workers must have broader skills and competencies

(knowledge workers must have a broad understanding of the ultimate goal of their work)

Main effect, at the organizational level, process orientation led to the characterization of high-level operations, called

**organizational business processes**

# Issues

- Process Orientation
- Organizational structures**
- Principal-contractor relationship
- Cases and procedures
- Process management

# Organizational structure

An **organizational structure** establishes how the work, authorities and responsibilities are divided up amongst its staff  
(**roles and functions**)

A single person can fulfill several roles,  
at the same time or at different times

# How to reduce bureaucracy



# Most relevant forms of organizational structure

## **Hierarchical:**

structured as a tree,  
internal nodes are individual roles/functions,  
leaves are staff or departments,  
branches are authority relationships  
(independent of cases)

# Hierarchical structure

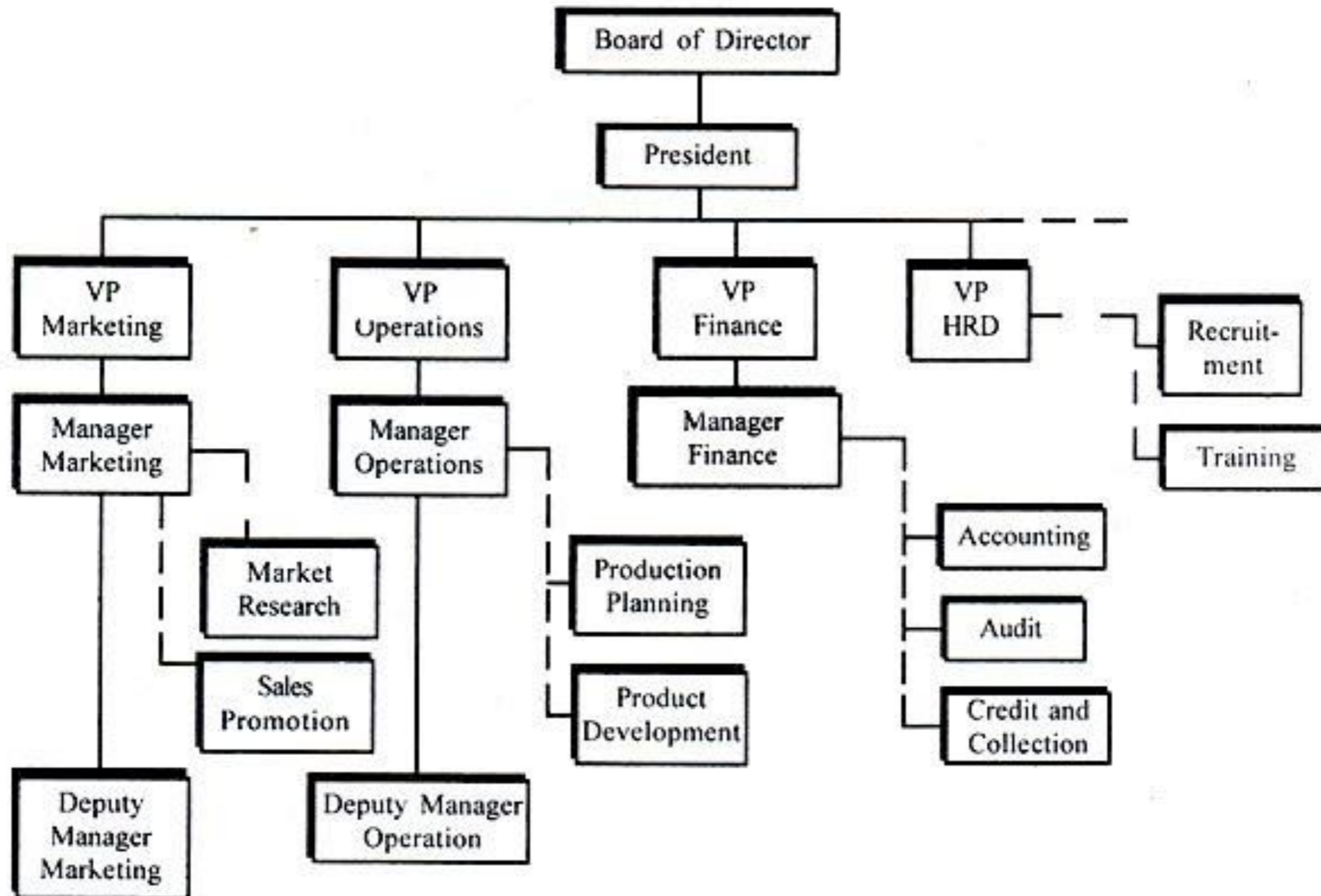

Legend : — Line Authority

-- Staff Relationship

# Most relevant forms of organizational structure

## **Matrix:**

add (dynamic) functional dimension  
(each person can have one or more functional bosses, known as project leaders)

# Matrix structure

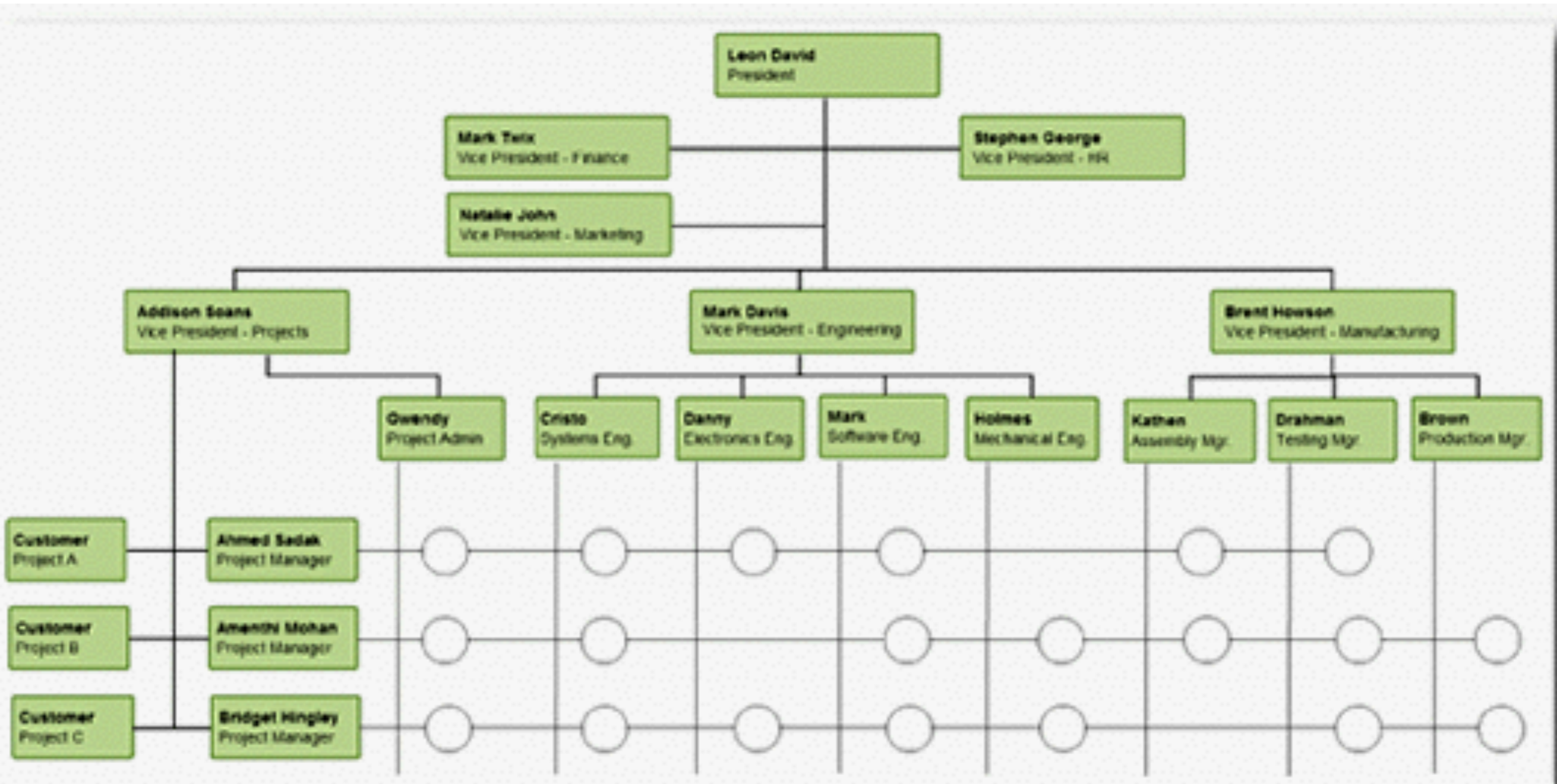



# Most relevant forms of organizational structure

## **Network:**

autonomous actors collaborate  
to supply products or services

# Network structure

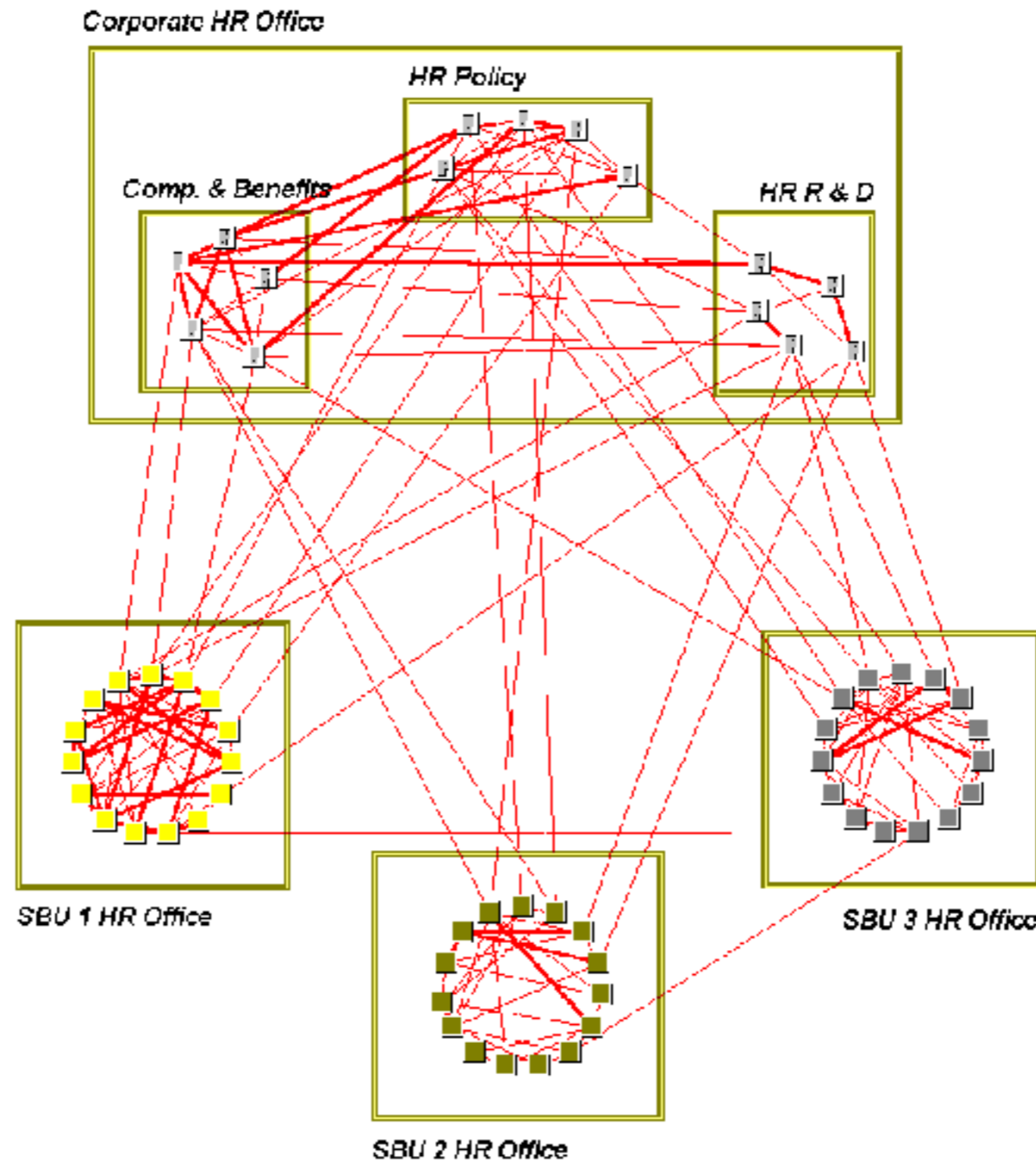

# Issues

- Process Orientation
- Organizational structures
- Principal-contractor relationship**
- Cases and procedures
- Process management

# Principal

Most people's work is assigned or outsourced to them by other people: their **principals** (they can be company departments or firms)

We can divide principals in two forms:  
**boss** and **customer**

Assignments ordered by bosses are often related to work for customers

# Contractors

A person who is assigned a task is called  
**contractor**, or also **resource**  
(assignments can be carried out by machines  
and computer applications as well as people)

# Actors

An **actor** can be a principal or a contractor, or  
play both roles at the same time  
(contractors may redirect work to third parties)

# Contract

A **contract** exists between a principal and a contractor about the case to be performed (deadline for completion, price to be paid)

A **communication** protocol can be established between a principal and a contractor to exchange information

# Protocol example

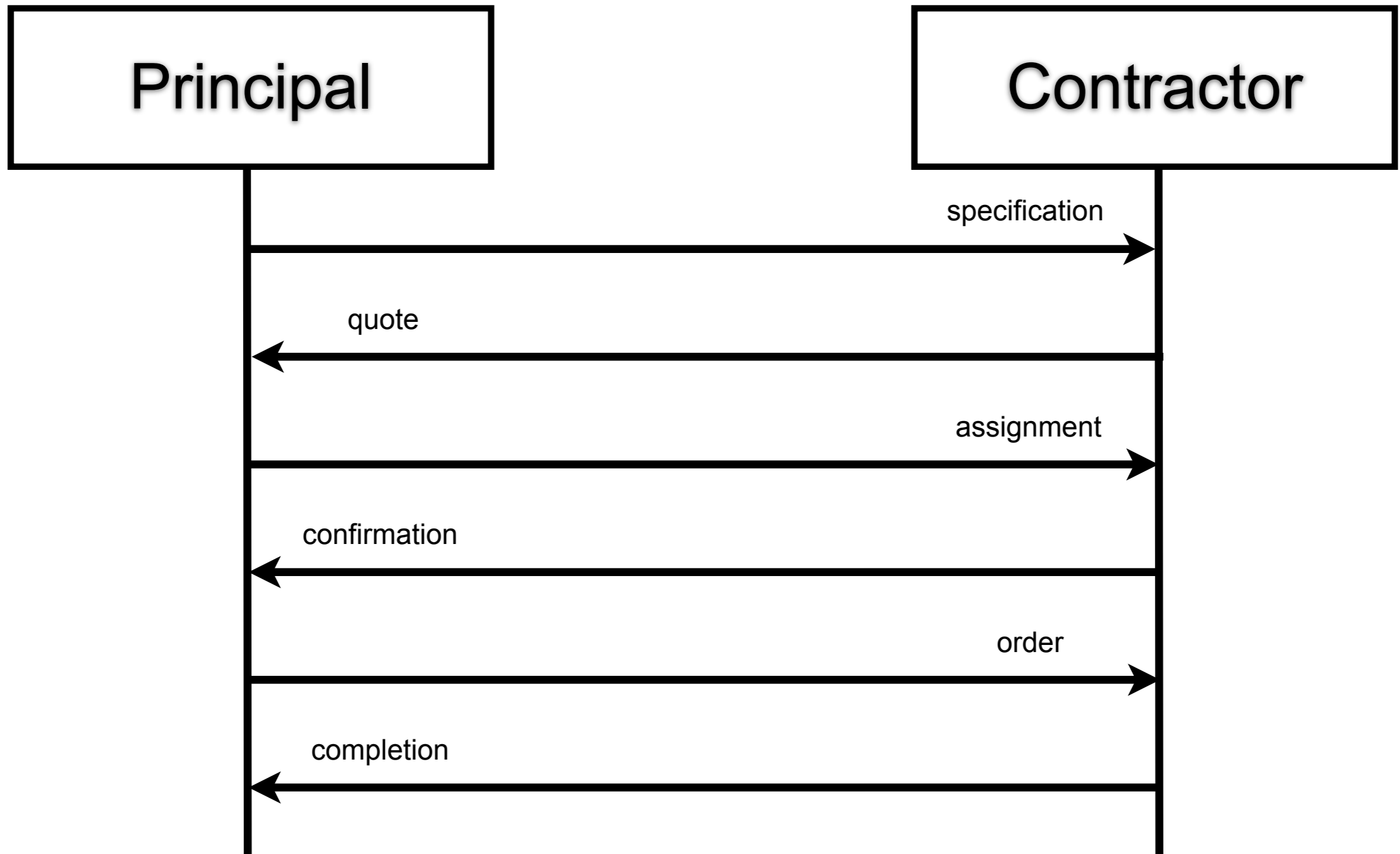



# Contract tree example

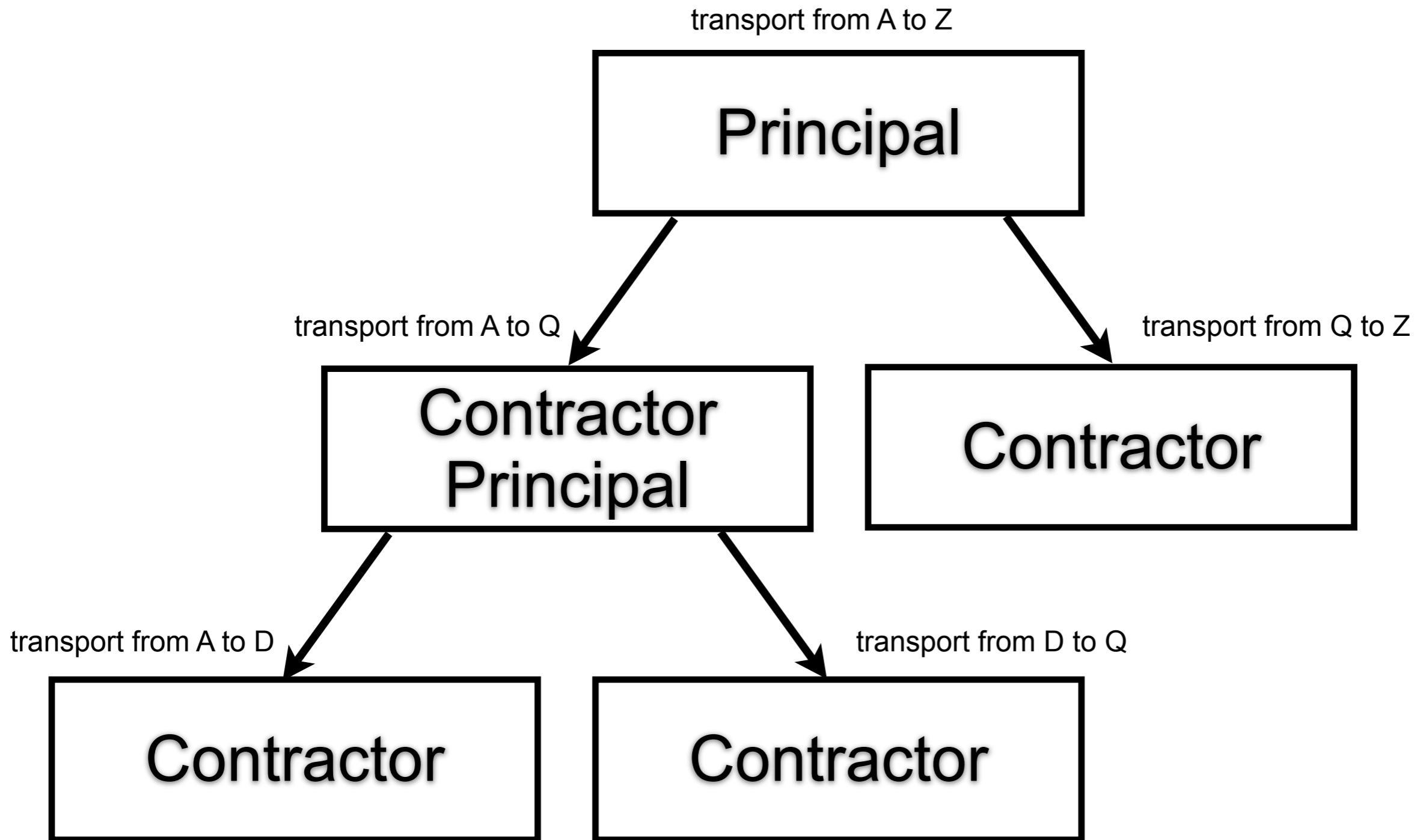

# Issues

- Process Orientation
- Organizational structures
- Principal-contractor relationship
- Cases and procedures**
- Process management

# Case

Many different types of work exist  
(baking bread, making furniture, design a building,  
collect surveys to compile a statistic)

They have in common the **case**:  
often one tangible thing produced or modified  
(bread, furniture, house, diagram)  
but more abstract cases are also possible  
(a lawsuit, an insurance claim, digital data)

**Synonyms:** work, job, product, service, item

# Procedure

Working on a case is typically discrete in nature

Every case has a beginning and an end

Each case can be distinguished from any other case

Each case involves a **procedure** being performed:  
the tasks to be carried out and the conditions that  
determine the order of the tasks

**Synonyms:** process, project

# Task

A **task** is a logical unit of work that is carried out as a single whole

# Example: Make a Pizza

1. Check ingredients
2. Check tools
3. Make the dough balls
4. Prepare toppings (while dough rises)
5. Shape dough balls into pizza
6. Top it
7. Cook it

Tasks?  
Procedures?  
Cases?



# Knowledge

Some tasks can be performed by a computer without human intervention

Executing some tasks may require human intelligence: a judgement or a decision  
(a bank employee decides about a loan request)

Persons need **knowledge** to execute tasks  
(their past experience, company guidelines)

# Resource

A **resource** is the generic name for a person, machine or group of persons or machines that is responsible for a task



# Activity

An **activity** is  
the performance of a task by a resource

Various cases may share the same procedure, but each case may involve different activities to be carried out, depending on case **attributes**  
(one insurance claim may involve objections and another one may not)

# Example: Make a Pizza

1. Check ingredients
2. Check tools
3. Make the dough balls
4. Prepare toppings (while dough rises)
5. Shape dough balls into pizza
6. Top it
7. Cook it

Knowledge?  
Resources?  
Activities?



# Example: Make a Pizza



Knowing the procedure is essential, but

Not all recipes are the same

Not all pizzas taste the same

Execution is important

Training is important

# Cases vs procedures

The number of procedures in a company is (generally) finite and far smaller than the number of cases to be handled

## **Example**

it is easier to make  
one hundred skirts with the same pattern  
than one hundred skirts using different patterns

(off-the-rack is cheaper  
than made-to-measure)

# Economy of scale

The cost per case falls  
as the number of cases increases

**Strategy:** keep the number of procedures small and  
make the number of cases that each can perform as  
high as possible

# Example

Insurance companies want to keep the number of claims as low as possible, but this is generally a factor they cannot control

They can try to **keep low the number of procedures**, but the risk is to make them too much complex (a unique procedure to handle all cases is possible in principle, but inefficient in practice)

## **Ideal situation:**

a small number of good procedures, with a lot of cases to be handled by each of them

# Counter-examples?

What about tailor-made suits?  
one case per process?

What about architects and houses?  
each case designed from scratch?

# Not so different?

Tailors and architects can exploit standard approaches for each case

Tailor process:  
take customer's measurement,  
show a number of patterns,  
modify the chosen pattern,  
choose the fabric,  
draw the pattern

**Observation:**  
task execution can be highly dependent on cases



# Issues

- Process Orientation
- Organizational structures
- Principal-contractor relationship
- Cases and procedures
- Process management**

# What is all about

Each **product** that a company provides to the market is the outcome of a number of **tasks** performed

Business processes are about activities **understanding, correlation, organization and improvement**

# Awareness

Process management systems  
**support and encourage**  
communication between employees  
and make their activities more controllable

Business process reengineering is based on the  
understanding that **rapid, radical redesign of**  
**business processes is the road to success**

# Process orientation roots (1990's)

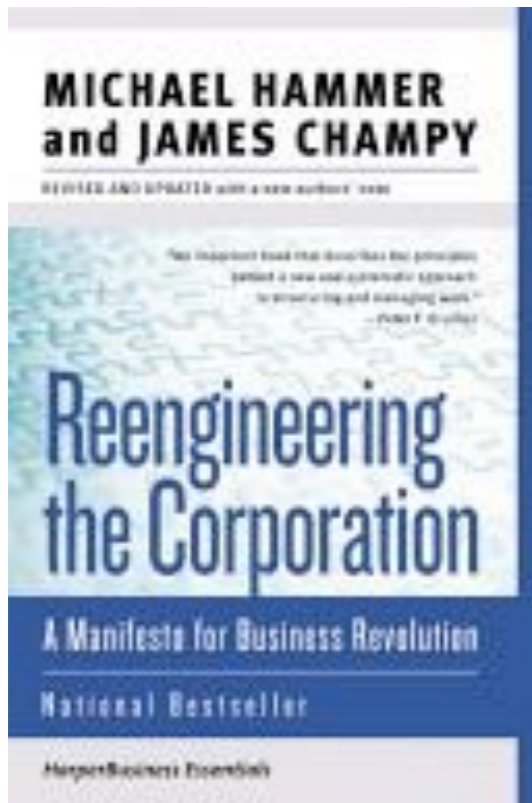

Seminal book advocating  
the radical redesign of the business  
process of a company  
(as opposed to evolutionary improvements)

A **business process** is a **collection of activities**  
that take one or more kinds of **input** and  
create an **output** that is of value to the customer

*- Hammer & Champy (1993)*

# How vs What

The main innovation is the shift of focus on the business logic of the process (**how work is done**), instead of the product perspective (**what is done**)

# Keywords

*Hammer & Champy:* **collection, input, output**

# Process orientation roots (1990's)

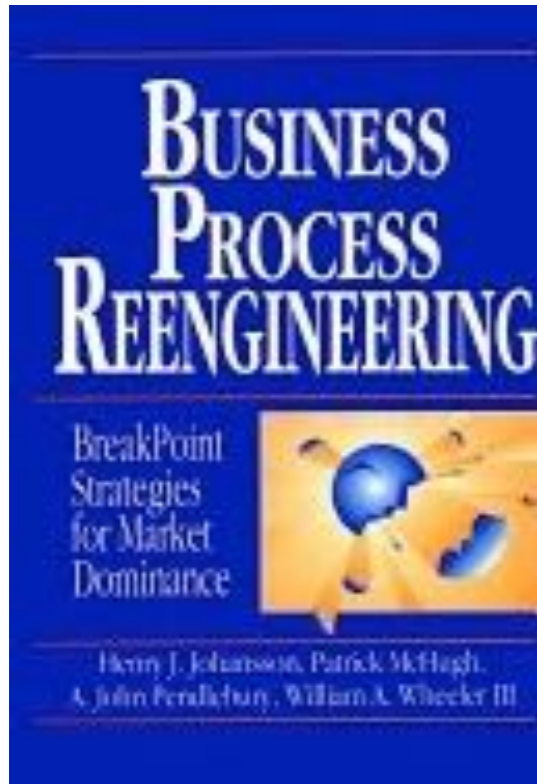

The transformation that occurs in the process should add value to the input and create an output that is more useful and effective to the **recipient**

A process is a set of **linked** activities that take an input and transform it to create an output.

- *Johansson et al. (1993)*

# Keywords

*Hammer & Champy:* **collection, input, output**

*Johansson et al.:* **recipient, linked**



# Process orientation roots (1990's)

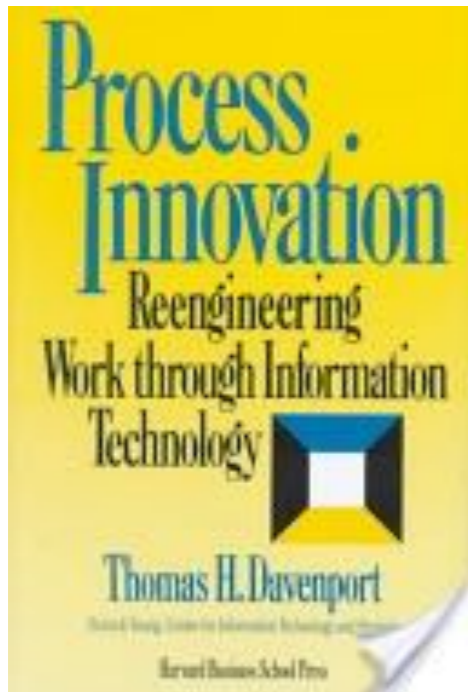

Processes as **structured** sets of activities designed to produce a specific output for a particular market

A **process** is a specific **ordering** of work activities across **time** and **space**, with a **beginning** and an **end**.

- *Davenport (1993)*

# More from Davenport

Unless designers or participants can agree on the way work is and should be **structured**, it will be very difficult to systematically improve, or effect innovation in, that work

Following a structured process is generally a good thing, and there is nothing inherently slow or inefficient about acting along process lines

# Keywords

*Hammer & Champy:* **collection, input, output**

*Johansson et al.:* **recipient, linked**

*Davenport:* **structure, ordering, time, space, begin, end**

# More from Davenport

Processes that are clearly structured are amenable to **measurement** in a variety of dimensions have cost, time, output quality, and customer satisfaction

When we reduce cost or increase customer satisfaction, we have bettered the process itself

# More from Davenport

Processes also need clearly defined **owners** to be responsible for design and execution.

Ownership must be seen as an additional or alternative dimension of the organizational structure.

During periods of radical process change, ownership **takes precedence** over other organizational structures. Otherwise process owners will not have the power or legitimacy needed to implement process designs that violate organizational charts and norms

# Keywords

*Hammer & Champy:* **collection, input, output**

*Johansson et al.:* **recipient, linked**

*Davenport:* **structure, ordering, time, space, begin, end, measurement, ownership**

# Process orientation roots (1990's)

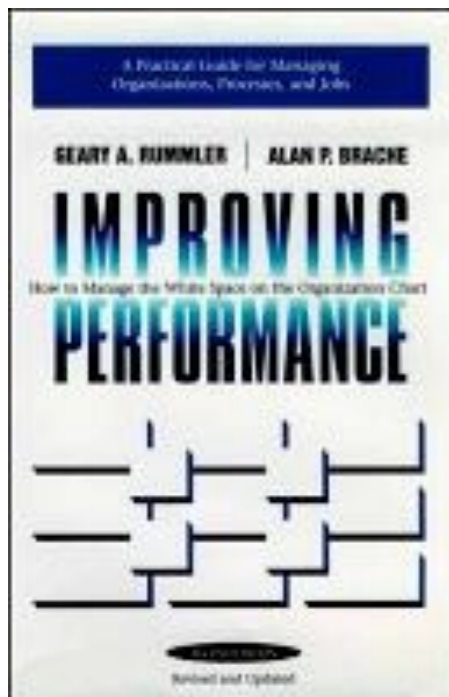

Some processes result in a product or service that is received by an organization's external customer. We call these **production** processes.

Other processes produce products that are invisible to the external customer but essential to the effective management of the business.

*- Rummler & Brache (1995)*

# Primary process

Produce company's products  
(**production** processes)

Customer-oriented, even if sometimes the customer is not known in advance

Generate income for the company

**Examples:** raw materials purchase, service sale, design and engineering, distribution



# Secondary process

Support primary processes  
(**support** processes)

**Examples:** machinery purchase and maintenance, personnel management (recruitment and selection, training, work appraisal, payrolls, dismissal), financial administration, marketing

# Tertiary process

Direct and coordinate primary and secondary ones  
(**managerial** processes)

Fix objectives, allocated resources and  
preconditions for the managers of other processes

**Examples:** maintenance of contracts with  
financiers and other stakeholders

# 1, 2, 3

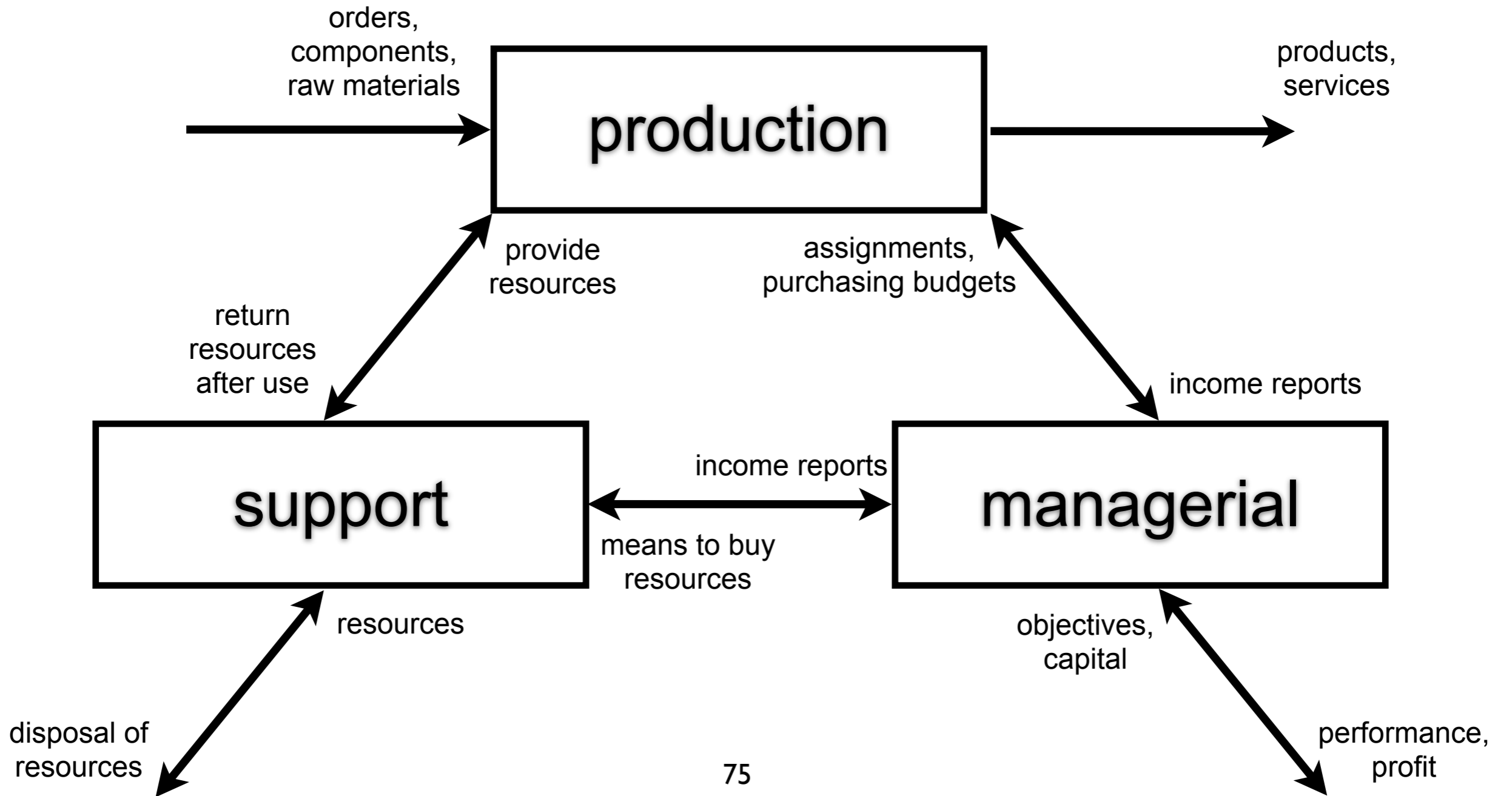

# Keywords

*Hammer & Champy:* **collection, input, output**

*Johansson et al.:* **recipient, linked**

*Davenport:* **structure, ordering, time, space, begin, end, measurement, ownership, innovation enabling**

*Rummler & Brache:* **production processes, support processes, managerial processes**

Summing up

# Definability

Processes must have clearly defined boundaries, input and output



# Structured

Processes wrap up a collection of tasks

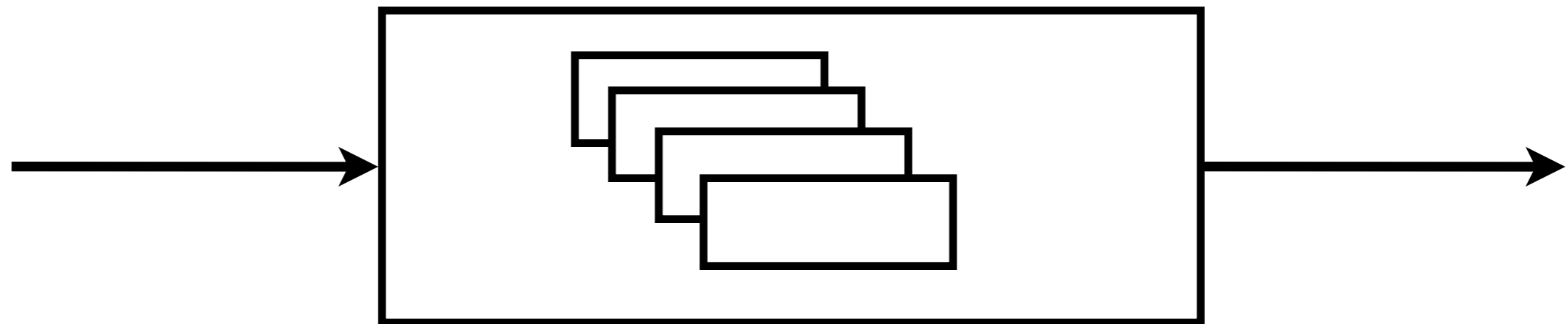

# Ordered

Process tasks are ordered according to their position in time and space

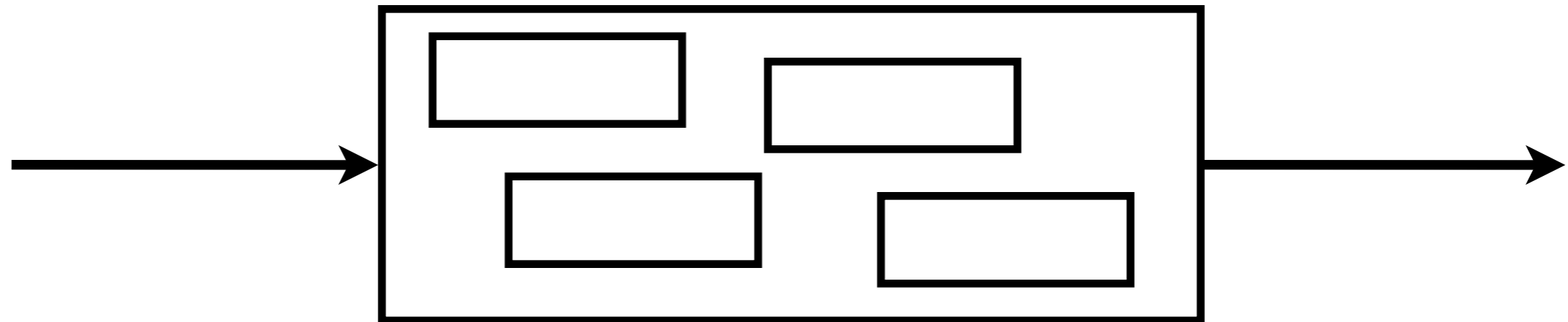



# Linked

Process activities are linked along a value-added chain

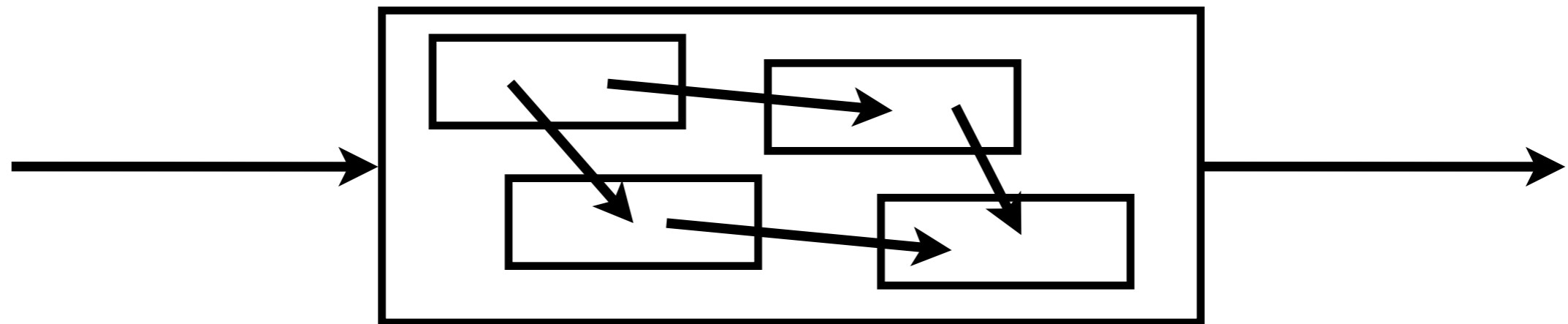

# Example

$S = \{a, b, c, d, e, f\}$

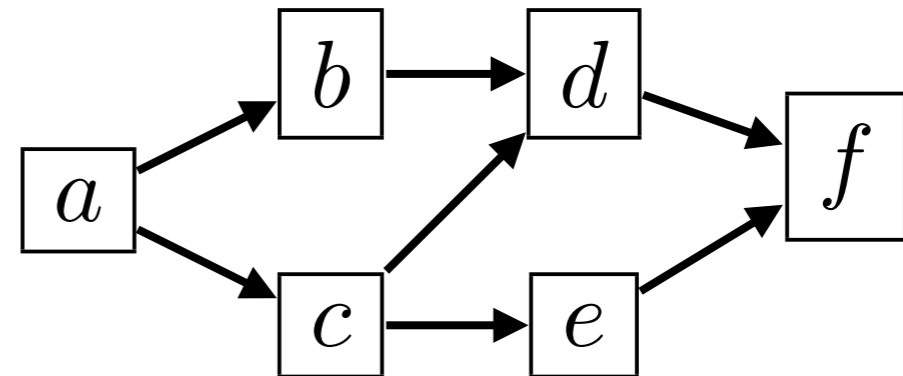

$a \sqsubseteq b \sqsubseteq d \sqsubseteq f$        $a \sqsubseteq c \sqsubseteq e \sqsubseteq f$        $c \sqsubseteq d$

Which of the following are correct sequences?

$abcdef$

$abcdef$

$abdcef$

$acebdf$

$acbdef$

$acefbd$

# Customer

The process output has a recipient

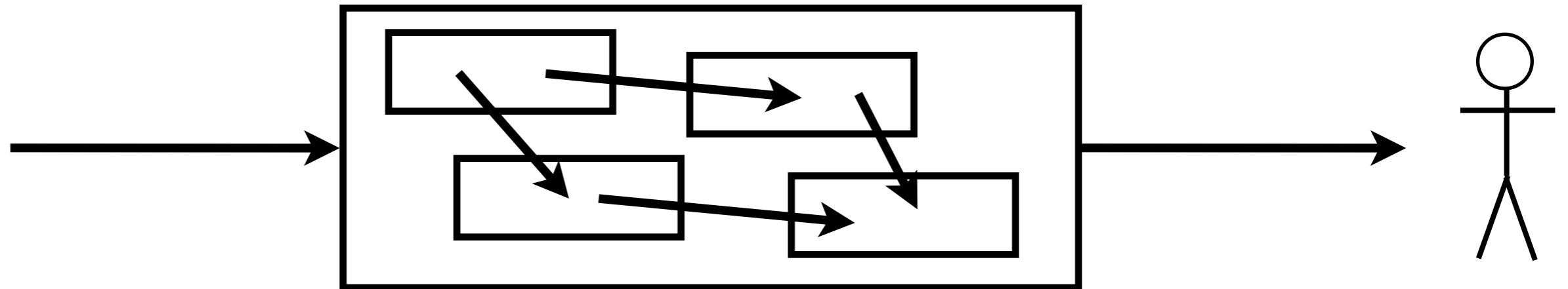

# Measurability

The process output can be measured and evaluated

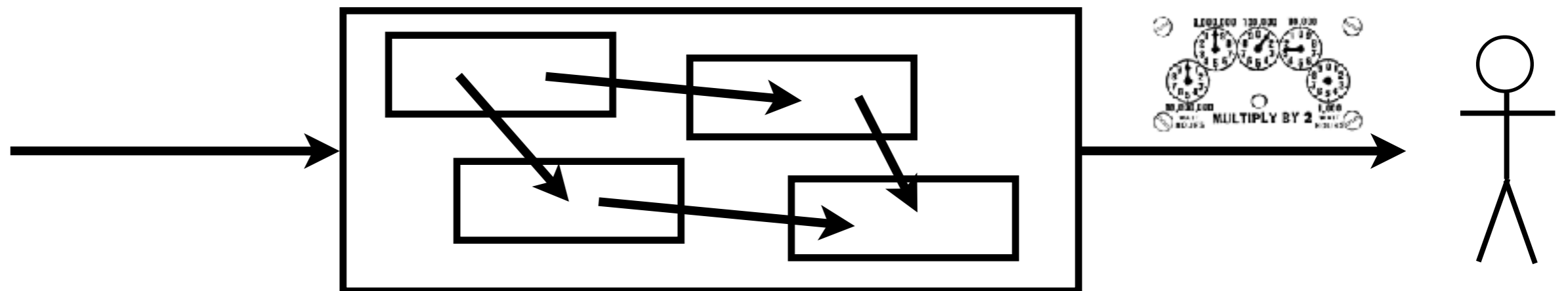

# Ownership

There is one responsible for the performance and continuous improvement of the process

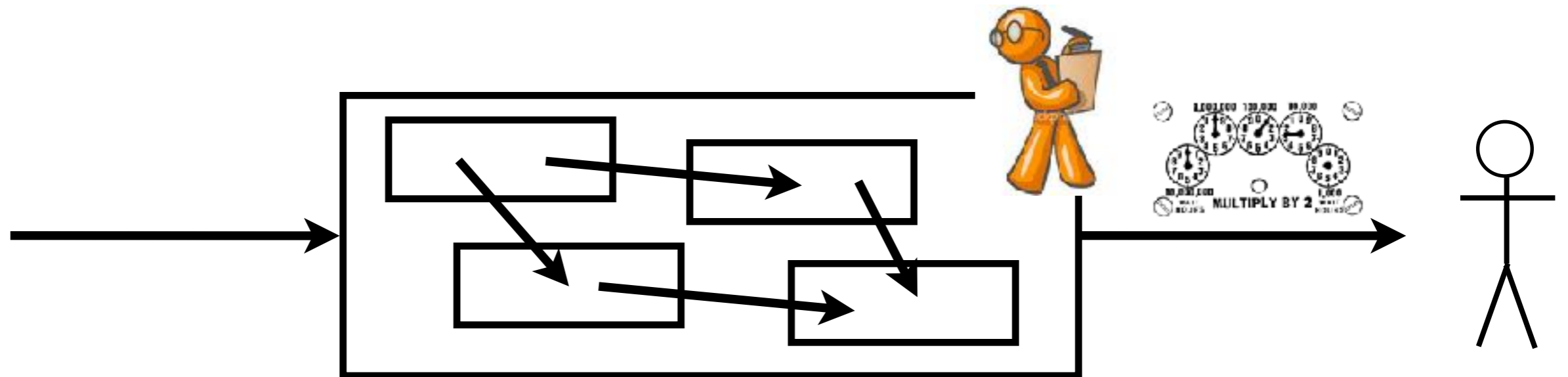

# Cross-functionality

A process can span several functions within and across the organizational structure

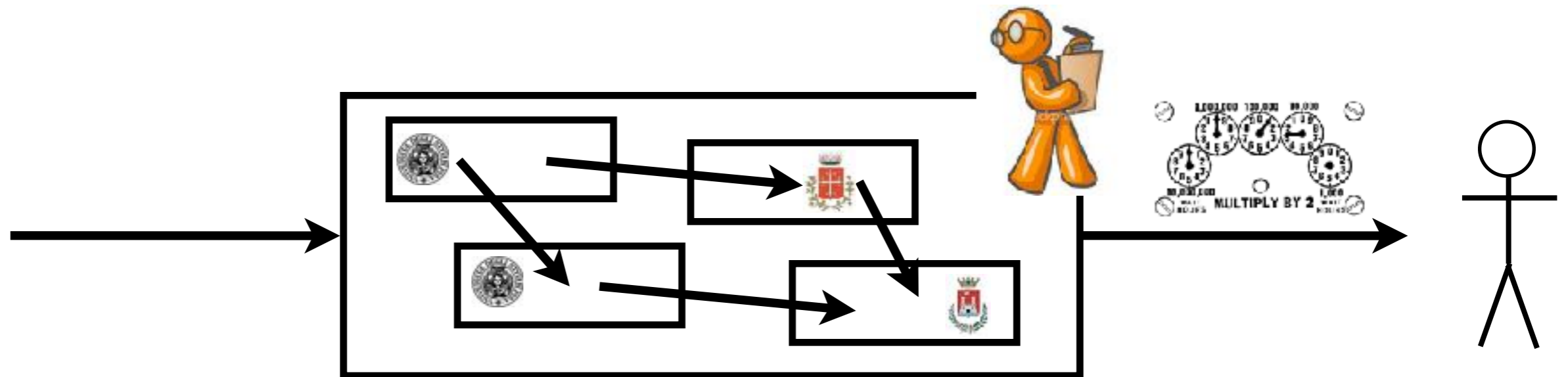

# Narrowing the gap

Organizational business aspects

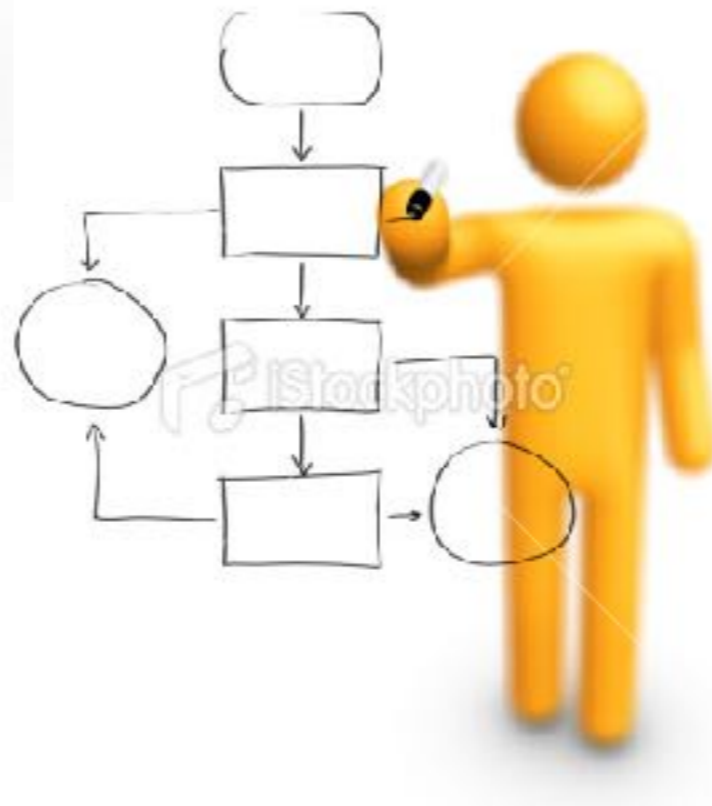

# Exercise

Invent your own diagrammatic notation  
to describe the following scenario  
(choose symbols, shapes, colours carefully)

Alice wants to sell her car, Bob is interested in buying it.

Alice asks some quote.

Bob can accept the bargain, refuse it or make a counteroffer.

Alice can accept or make a counteroffer and so on,

Until either the bargain is accepted or refused.