

Corso di Robotica (ROB)



Modulo di Robotica Bioispirata

La visione nell'Uomo

Cecilia Laschi

Istituto di BioRobotica, Scuola Superiore Sant'Anna

cecilia.laschi@sssup.it

L'occhio e la visione



- L'occhio e la retina
- I fotorecettori: coni e bastoncelli
- Il rilevamento di elementi di base nell'immagine: contorni, colori
- La proiezione dell'immagine sulla corteccia cerebrale
- I movimenti oculari

L'occhio umano

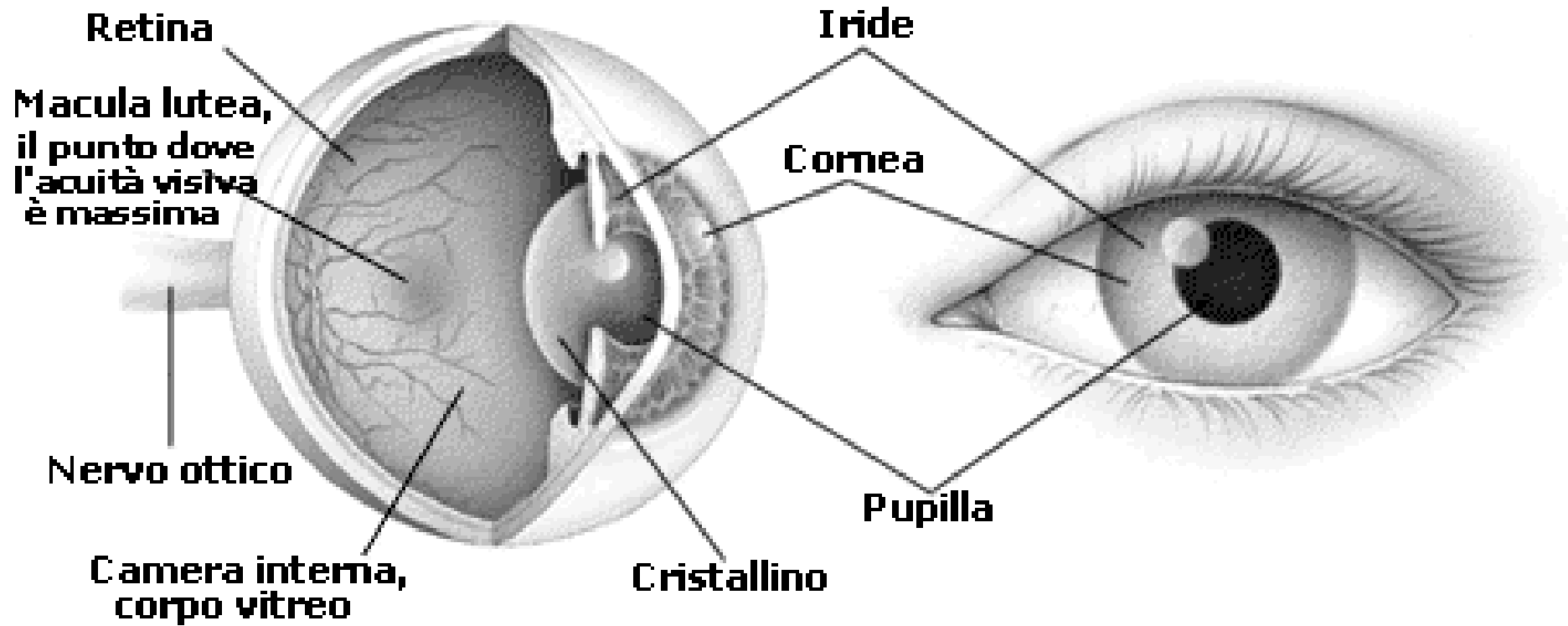

Formazione delle immagini nell'occhio umano

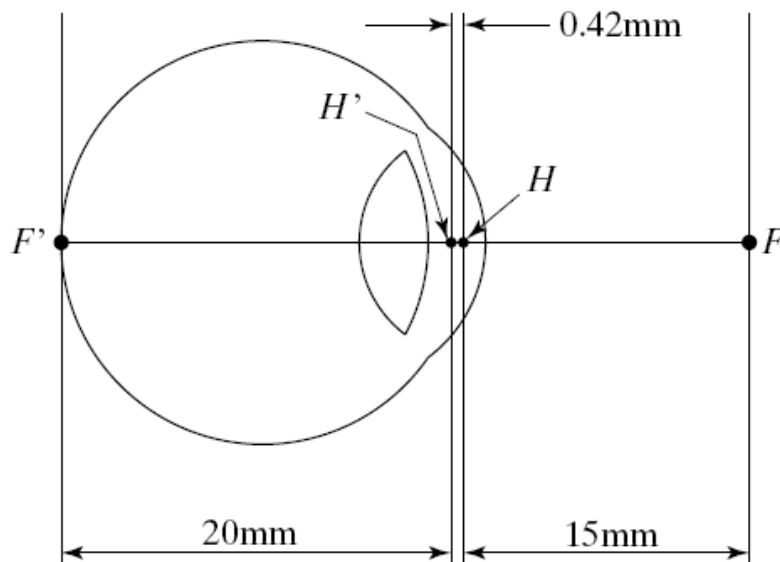
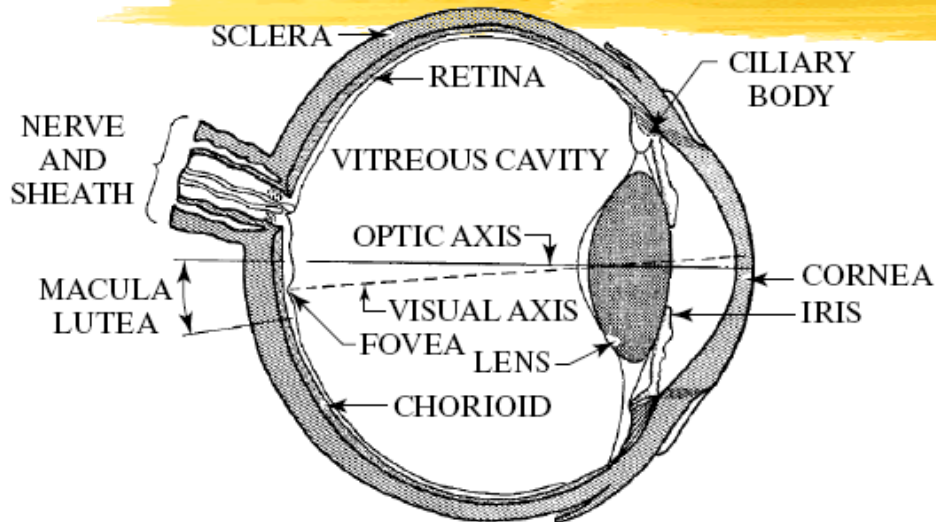

- Controllo dell'esposizione
 - Iride, pupilla (1-8 mm)
- Rifrazione della luce
 - Cornea, cristallino
- Formazione immagine
 - Retina
- Campo visivo
 - $160^\circ \times 135^\circ$
 - 330-730 nm

La proiezione delle immagini nell'occhio

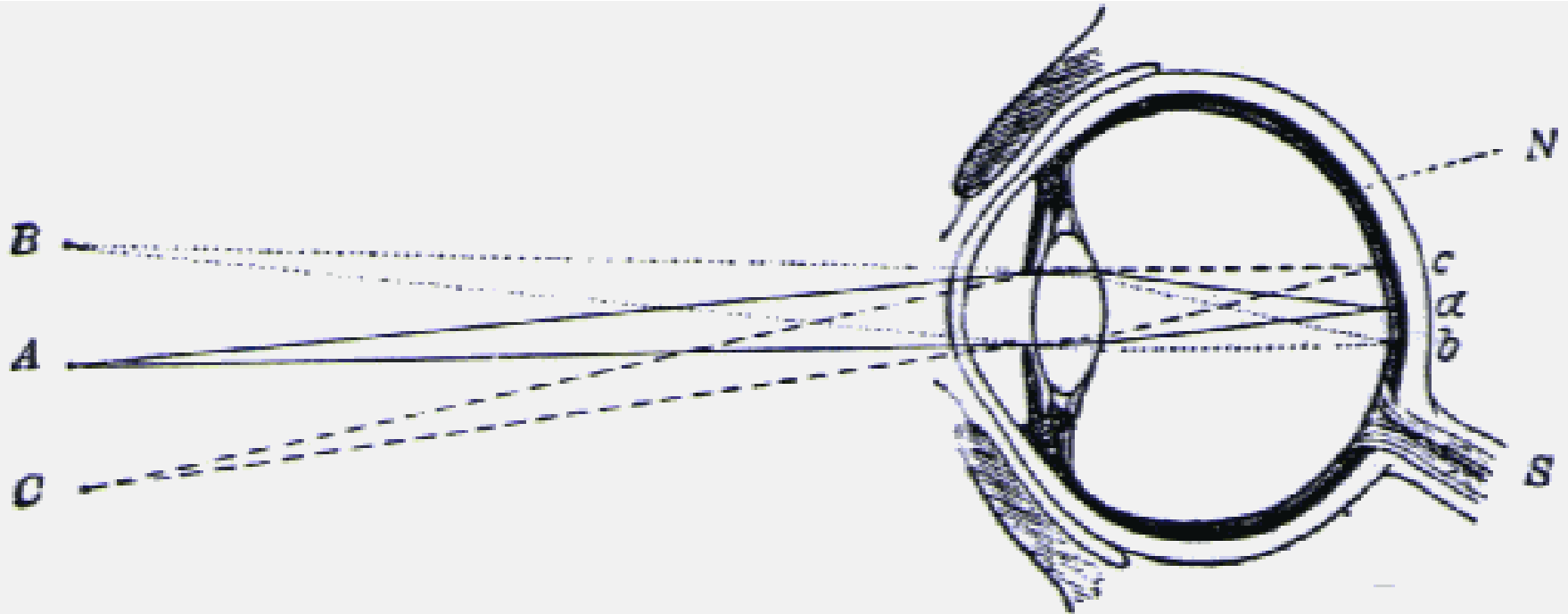

La formazione delle immagini nell'occhio

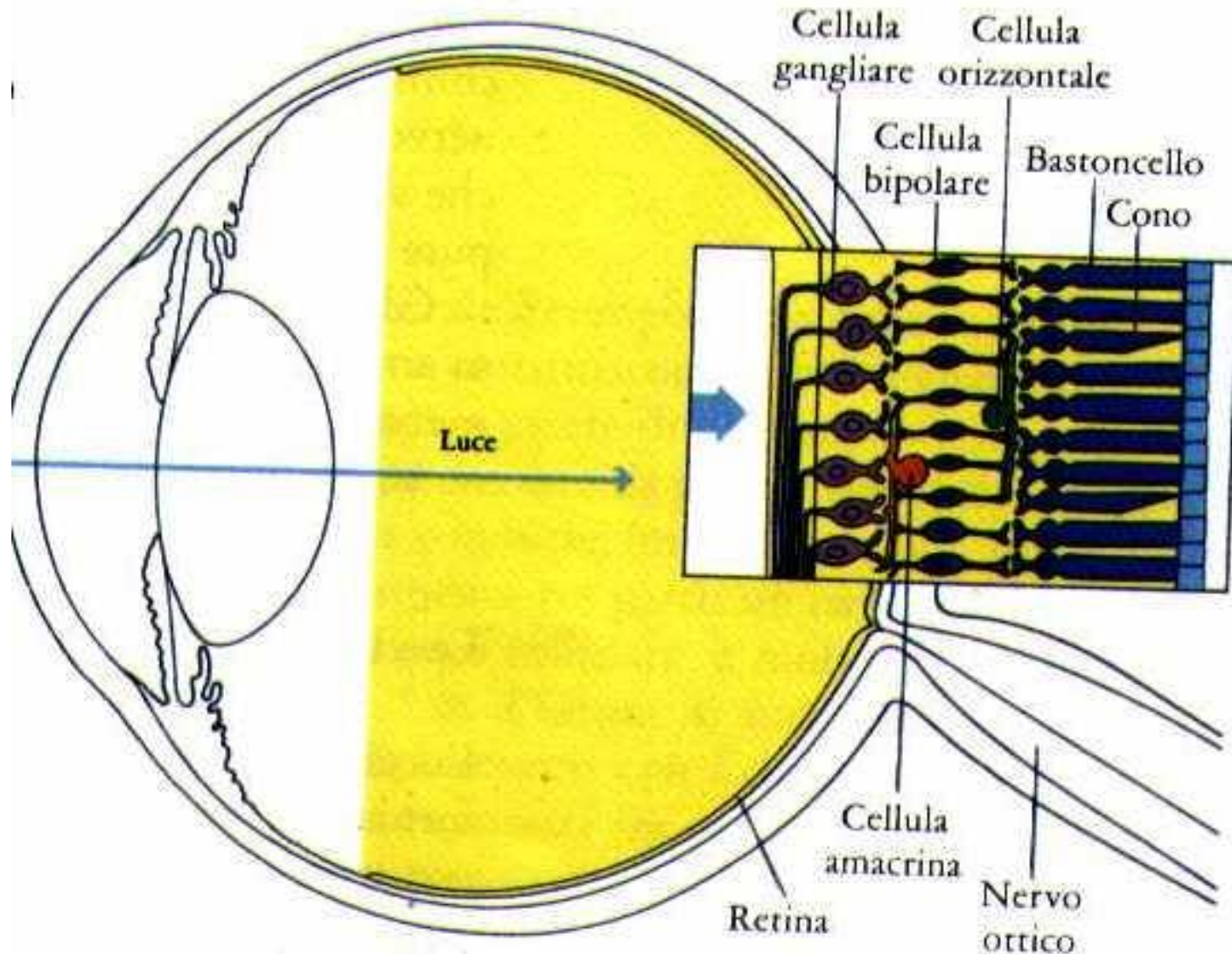

Il neurone: anatomia

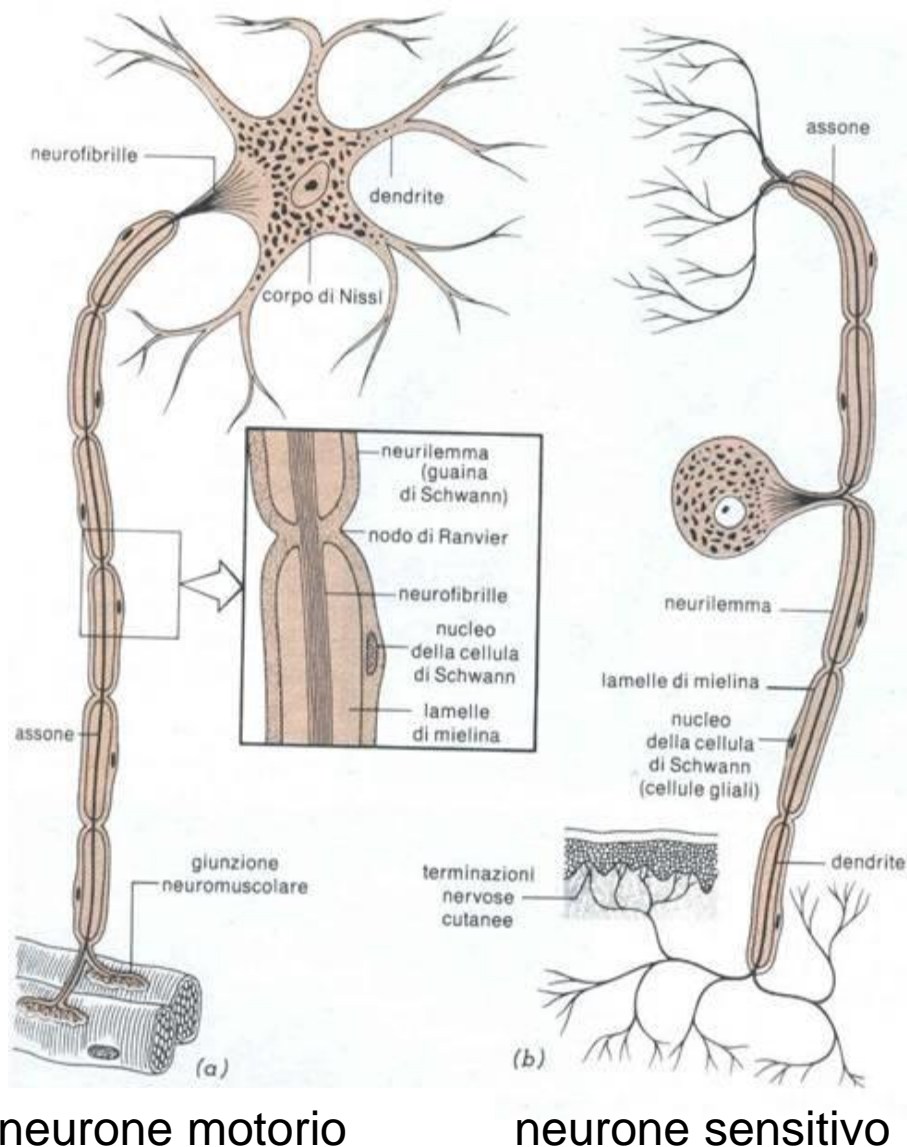

- Si può schematizzare il neurone in 4 parti principali:
1. Il corpo cellulare (soma)
 2. un prolungamento assonico
 3. un insieme di dendriti (strato d'input)
 4. un insieme di terminazioni sinaptiche (strato d'output)

Il neurone: le sinapsi

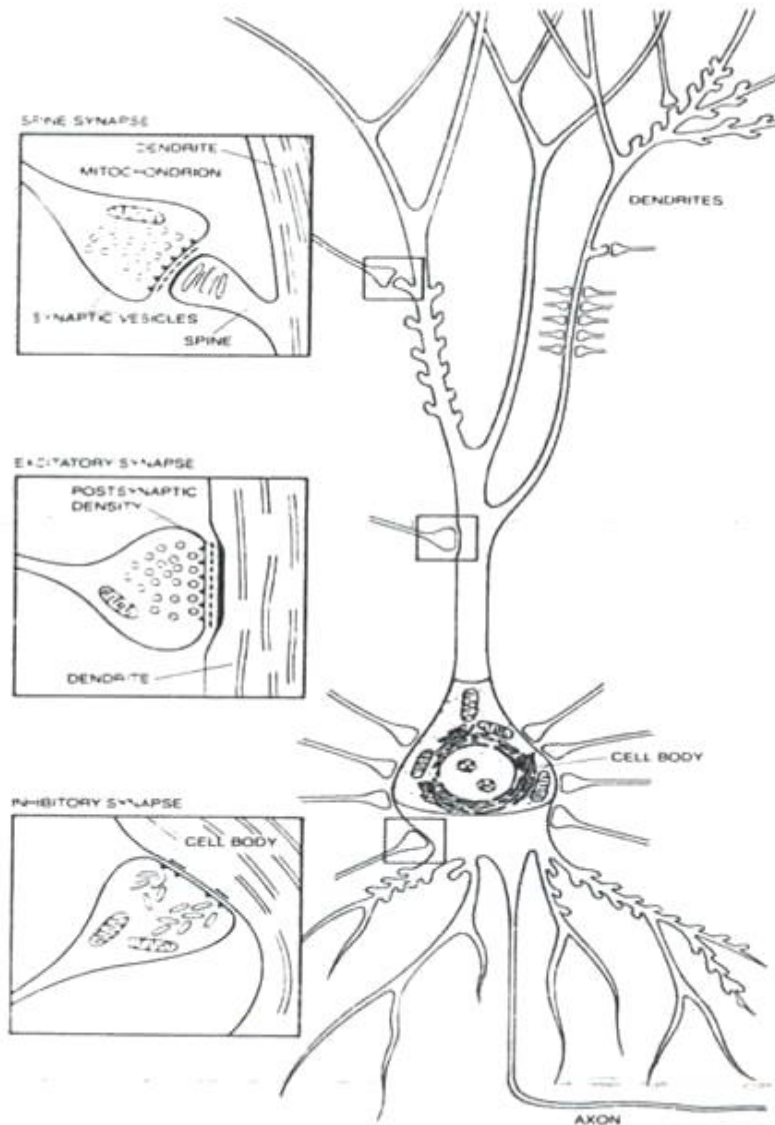

Le terminazioni sinaptiche controllano la trasmissione degli impulsi nervosi da un neurone all'altro tramite rilascio di sostanze chimiche (*neuro-trasmittitori*) contenute all'interno di vescicole presenti nelle terminazioni presinaptiche. I neuro-trasmittitori si diffondono attraverso le fessure sinaptiche e vengono "catturati" da appositi recettori post-sinaptici generando un flusso di corrente verso la membrana che avvolge il soma del neurone target.

I fotorecettori: coni e bastoncelli

1. Light activates sensitive receptors
Cones by different colors

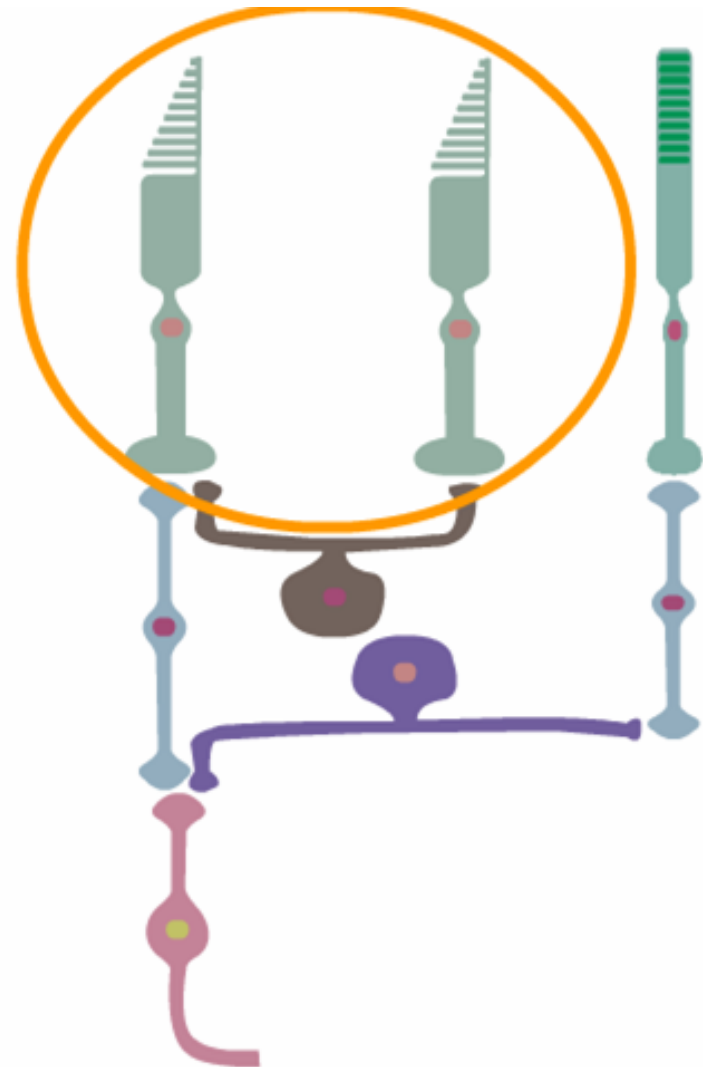

I fotorecettori: coni e bastoncelli

1. Light activates sensitive receptors
Cones by different colors
Rods by black and white

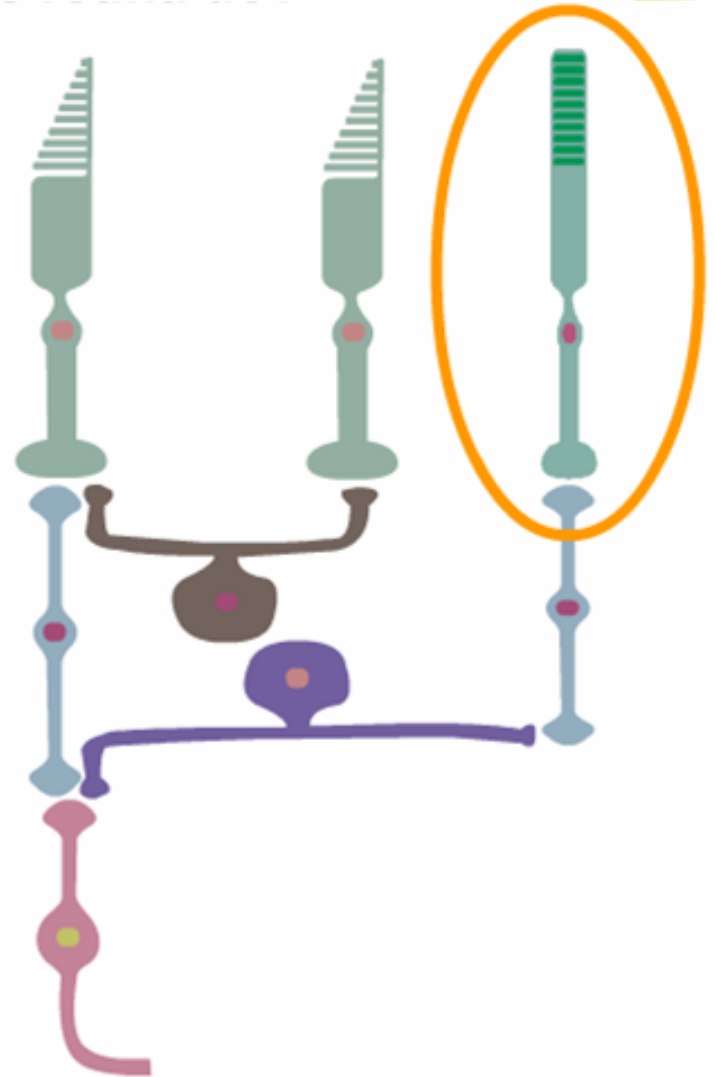

I fotorecettori: coni e bastoncelli

1. Light activates sensitive receptors
Cones by different colors
Rods by black and white
2. Ganglion cells are
the only output from the eye.

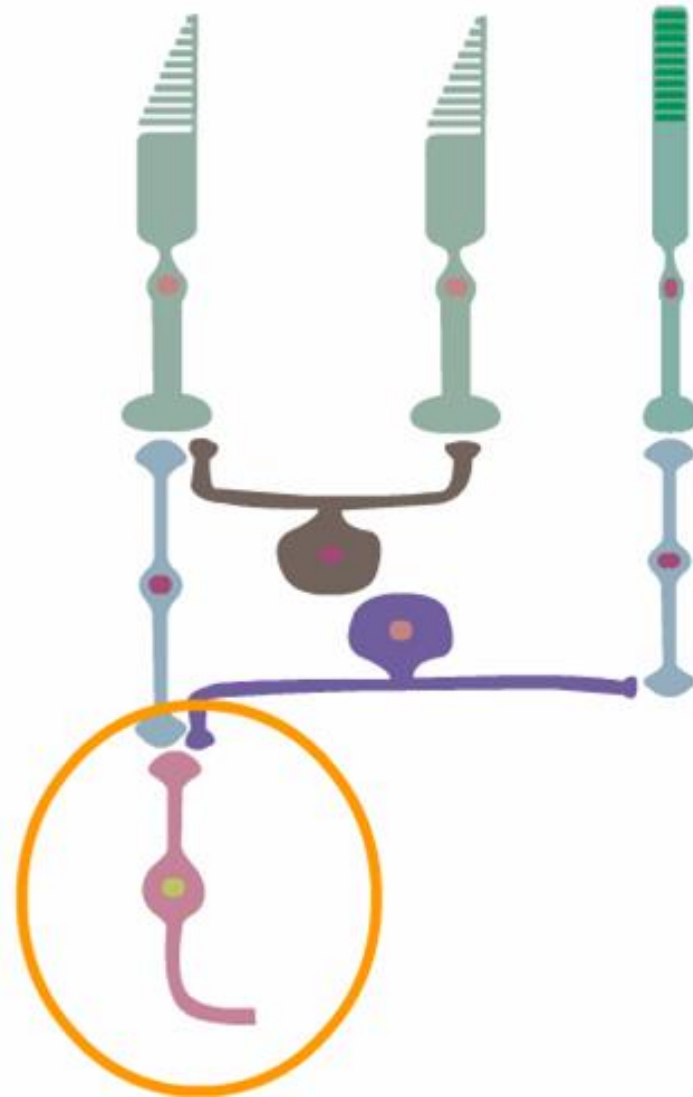

I fotorecettori: coni e bastoncelli

1. Light activates sensitive receptors
Cones by different colors
Rods by black and white
2. Ganglion cells are
the only output from the eye.
3. Bipolar cells connect
the receptors to the ganglion cells.

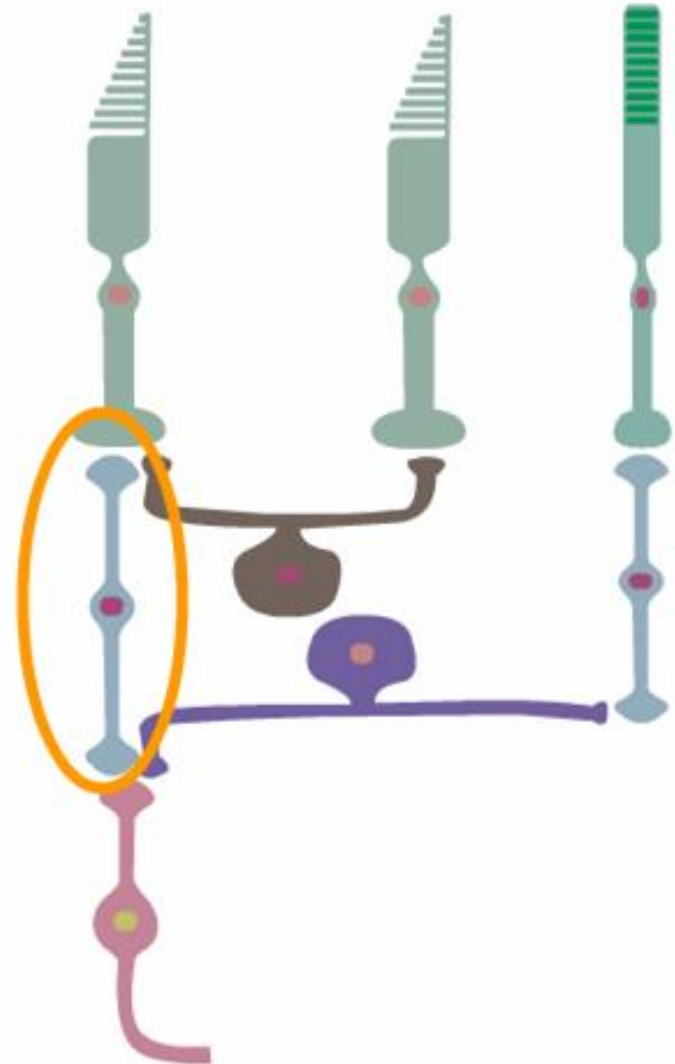

I fotorecettori: coni e bastoncelli

1. Light activates sensitive receptors
Cones by different colors
Rods by black and white
2. Ganglion cells are
the only output from the eye.
3. Bipolar cells connect
the receptors to the ganglion cells.
4. Horizontal cells
converge signals from several cones.
They determine how many receptors
each ganglion cell sees.

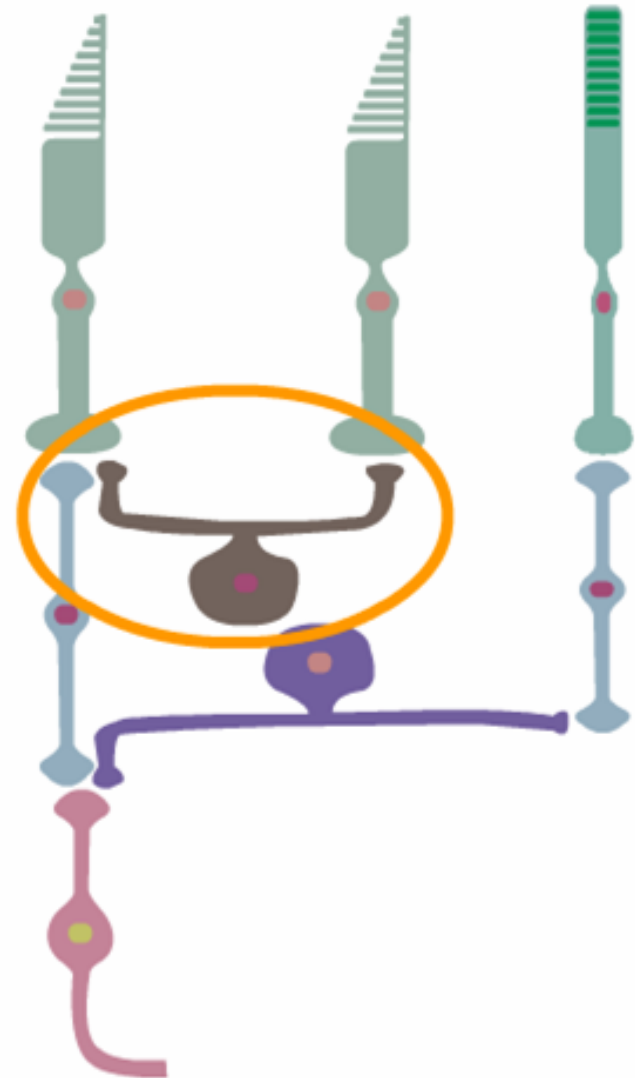

I fotorecettori: coni e bastoncelli

1. Light activates sensitive receptors
Cones by different colors
Rods by black and white
2. Ganglion cells are
the only output from the eye.
3. Bipolar connect
the receptors to the ganglion cells.
4. Horizontal cells
converge signals from several cones.
They determine how many receptors
each ganglion cell sees.
5. Amacrine cells do the same
from peripheral rods.

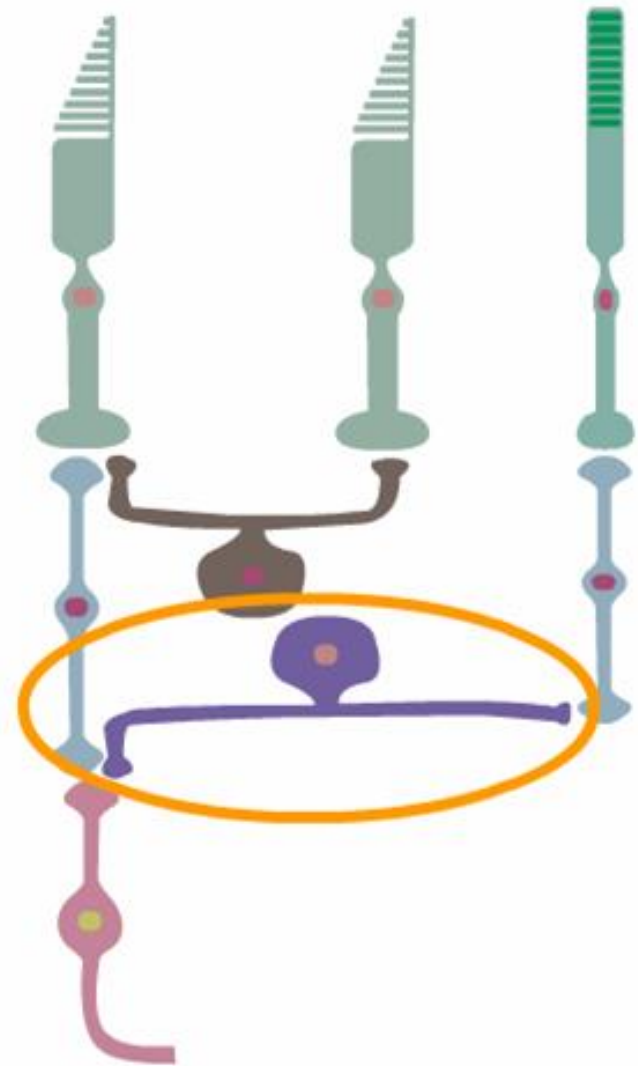

La distribuzione dei fotorecettori nella retina

the retina is not uniform.

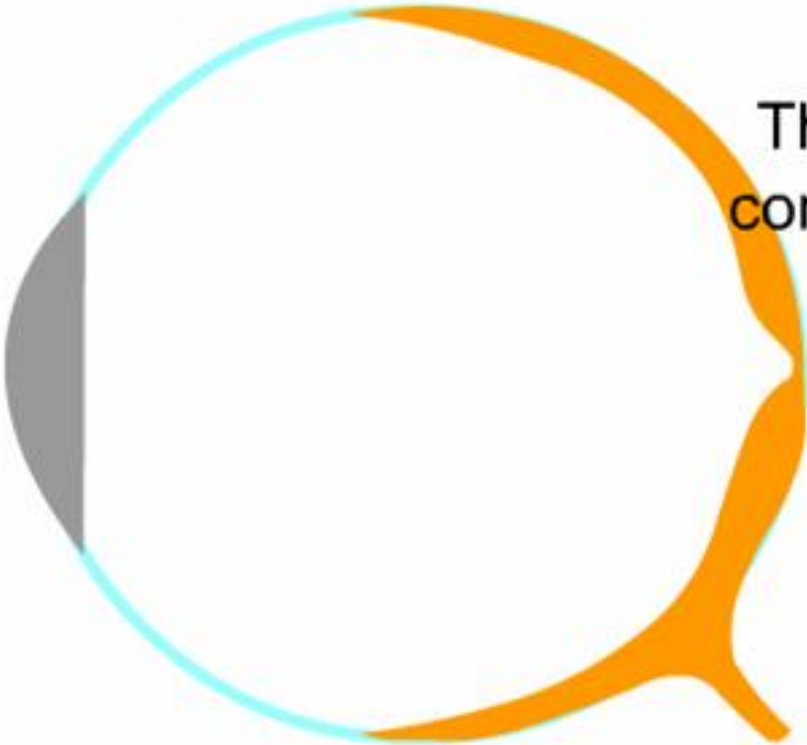

The **peripheral** retina contains primarily **rods**.

The **fovea**, in the center of the eye, contains only **cones**.

Sensibilità dei fotorecettori

the rods and cones are not equally sensitive to low light levels.

Cones are less sensitive to light.

e.g. Looking at dim stars, one can see stars in the periphery but they disappear when you look at them with your fovea. In very low levels of illumination, we see only with our rods and therefore see greys not colours.

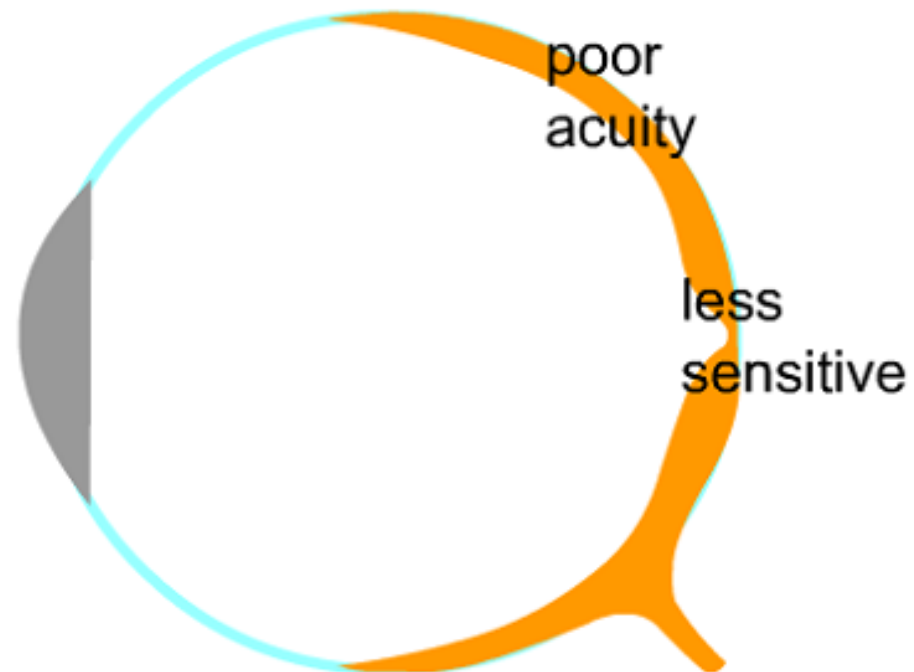

the periphery has poor acuity.

La distribuzione dei fotorecettori nella retina

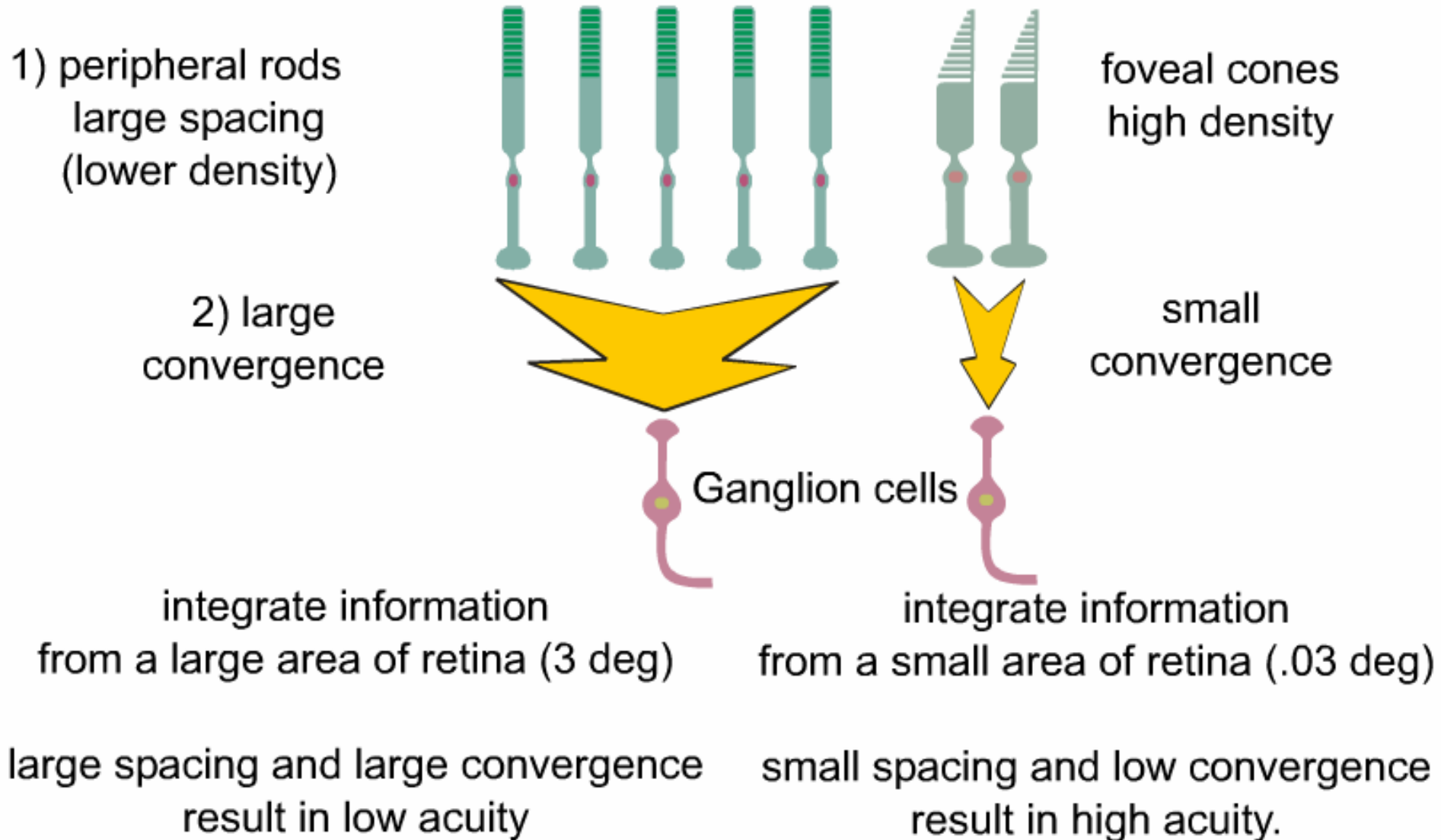

I campi recettivi

Definition of the receptive field
of a ganglion cell:

*“That area of retina
over which light stimuli
change the activity
of a particular ganglion cell.”*

The receptive field shows
which rods & cones
are connected to the ganglion cell.

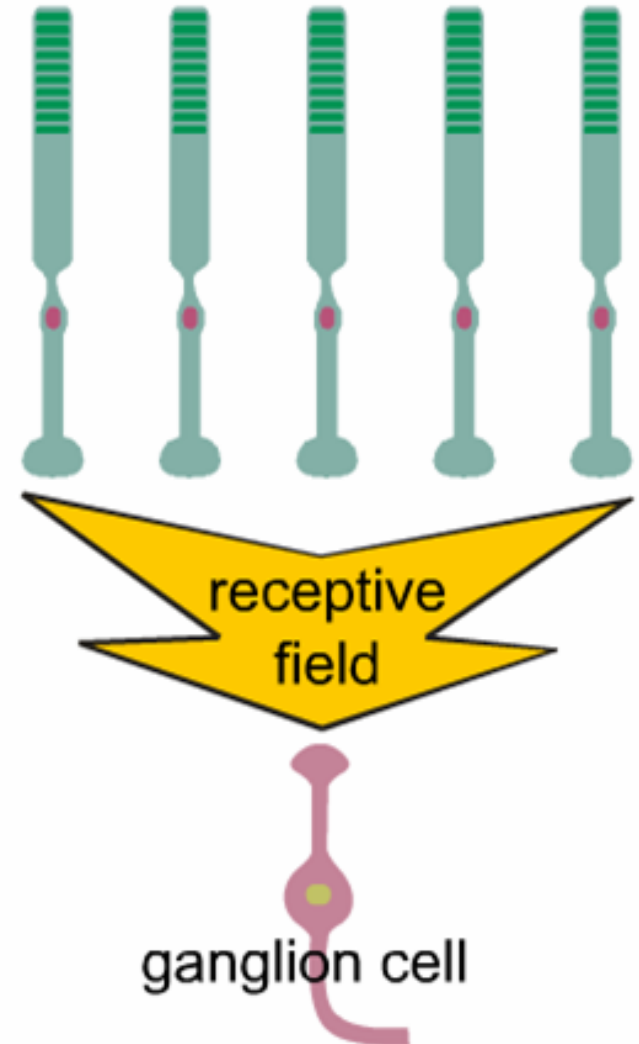

What the eye sees



By daylight,
only the central fovea sees
clearly and in color

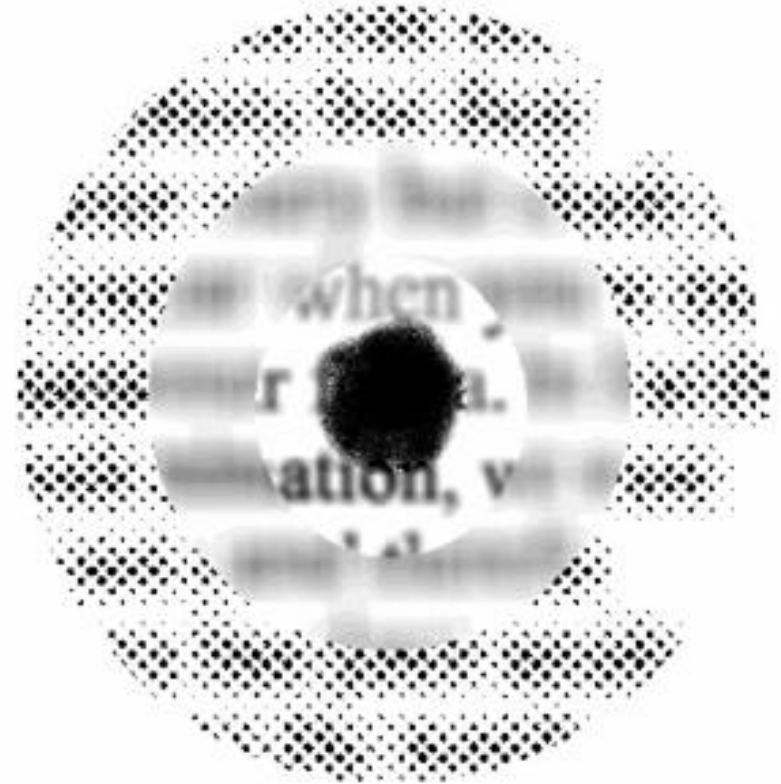

On a dark night,
only the periphery sees
only in
black & white,
and with poor resolution.
The fovea is blind

Why is compression important?

There are 100 million rods and cones. Why not have the same number of ganglion cells instead of the actual 1 million?

The answer is efficiency. Much of the information that the eyes sees is redundant. Through evolution the eye has been designed to remove this redundant information before sending it on to the brain. Why build and maintain a huge number of fibers when a much smaller number can convey the same information? When the eye sees a round image, it does not transmit the color and brightness of every point inside the image; only that at the edges.

This is similar to computer compression software used to transmit large images along the Internet. The ganglion cell sends compressed information down the optic nerve. The visual cortex then uncompresses this information. Suppose you were transmitting the color of a series of dots along the internet, each colour coded by a number from one to 2000000. The series uncompressed would look like: 1756333, 1756333, 1756333, 1756335, 1756335, 1756333 Compressed, by coding only changes in color, it would look like: 1756333,0,0,2,0,-2.... a lot shorter.

Tipi di campi recettivi delle cellule gangliari della retina

What are the two major types of receptive fields of retinal ganglion cells?

- (a) ON center, OFF surround which measure how much brighter an object is than its background.
- (b) OFF center, ON surround which measure how much darker an object is than its background.

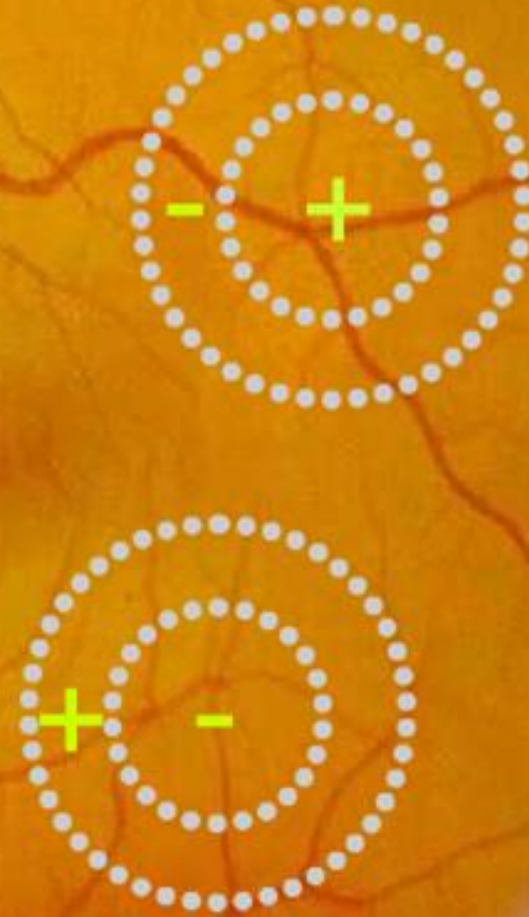

Campi recettivi "centro-on"

Light to a cone in the centre produces excitation of the ganglion cell.

This is because:

- 1) light decreases the cone voltage and the cone releases less inhibitory transmitter
- 2) the voltage inside the bipolar cell increases and it releases more transmitter
- 3) the ganglion cell is excited and it fires more often.

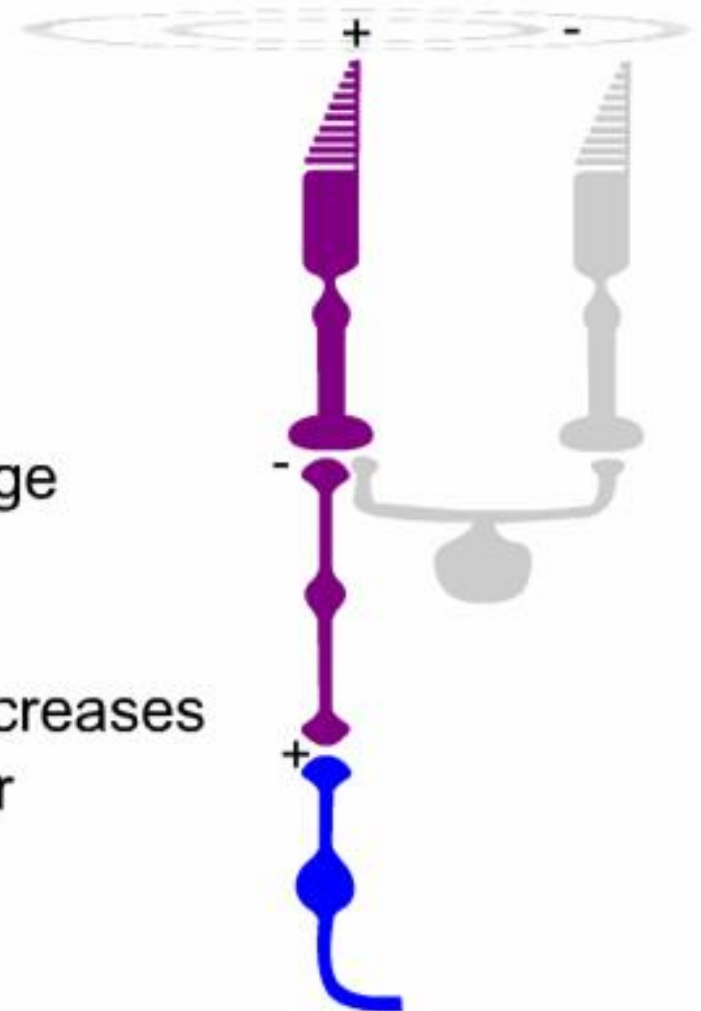

Campi recettivi "centro-on"

Light to a cone in the surround produces inhibition of the ganglion cell.

This is because:

- 1) light decreases the surround cone's voltage and the cone releases less excitatory transmitter
- 2) the voltage inside the horizontal cell decreases and it releases less inhibitory transmitter
- 3) the voltage inside the center cone increases and it releases more inhibitory transmitter
- 4) the voltage inside the bipolar cell decreases and it releases less excitatory transmitter
- 5) the ganglion cell is inhibited and it fires less often.

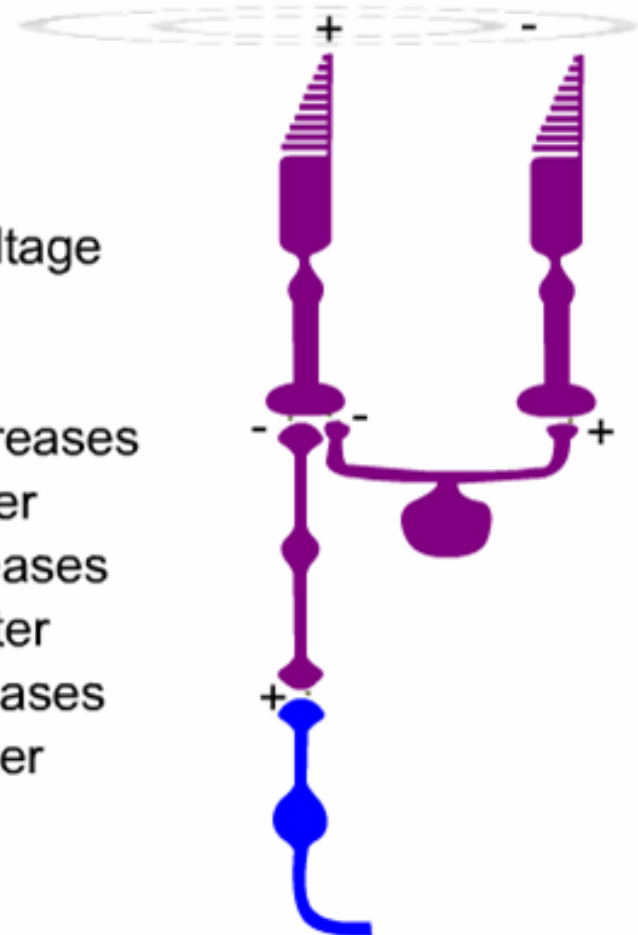

What important information is extracted by the retinal neural network?

These on-center ganglion cells are unaffected because the center and surround cancel.

Only at the edges is the activity excited or inhibited



the retina sees an image of this shape

What important information is extracted by the retinal neural network?

Ganglion cells exaggerate the contrast at borders (i.e. like a cartoon).

Why? By sending only the information on contours, the changes in brightness, less redundant information is sent along the small optic nerve to the CNS.



ganglion cells see an edge

La percezione del colore

Cones responds best to a particular wavelength of light and less to others.

Note that this one responds best to green light.

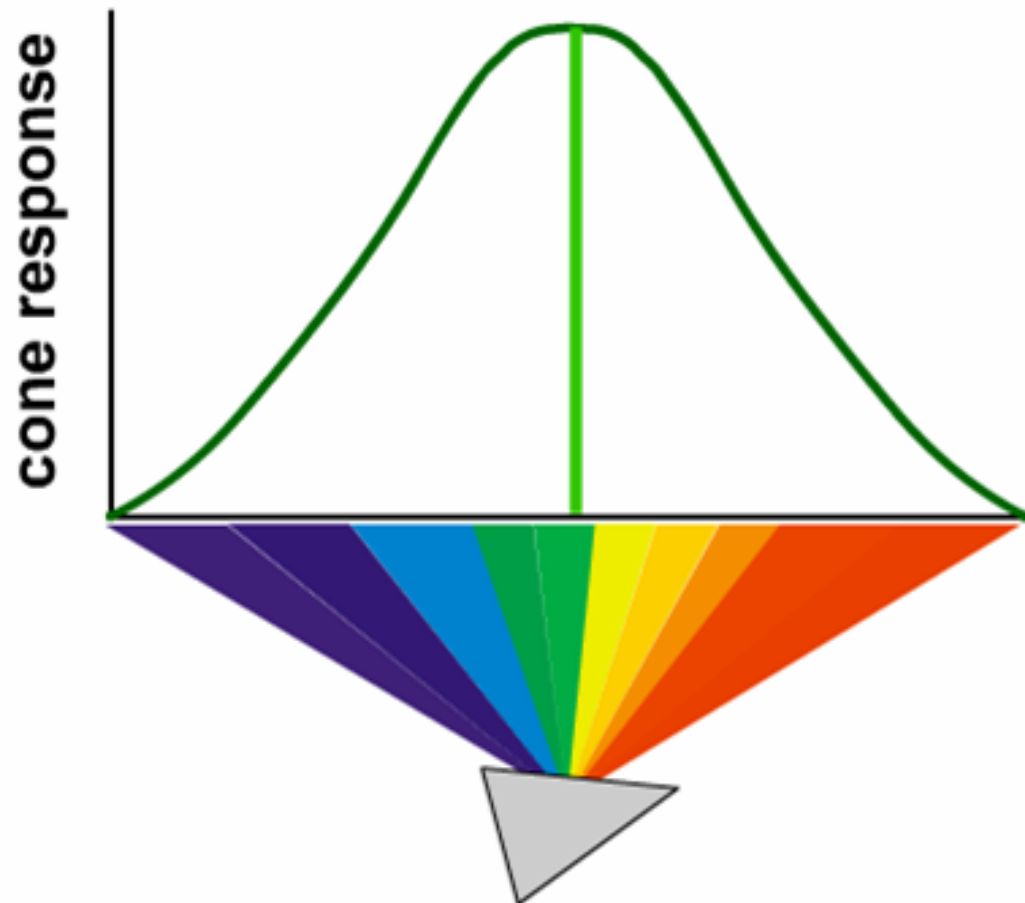

We have 3 cone types.

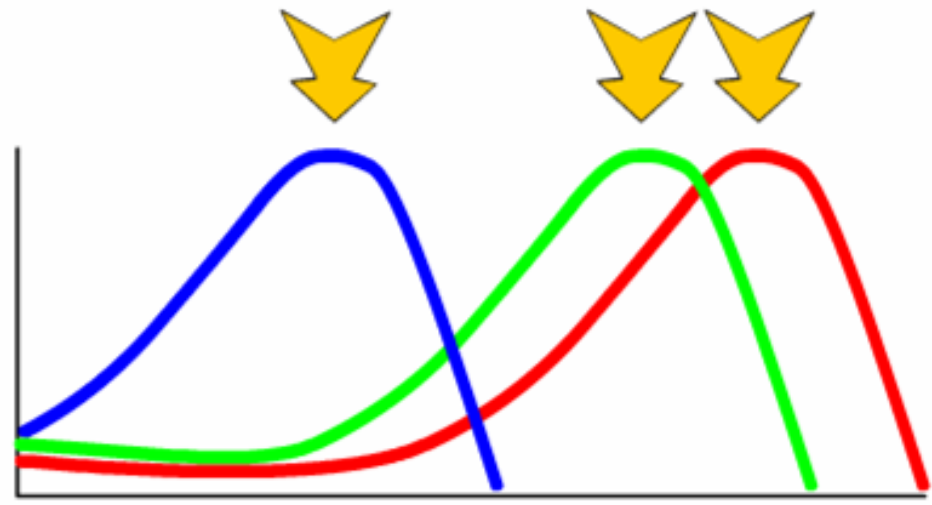

Mixing light is **not** like mixing paint.

When red & green cones are stimulated one sees yellow

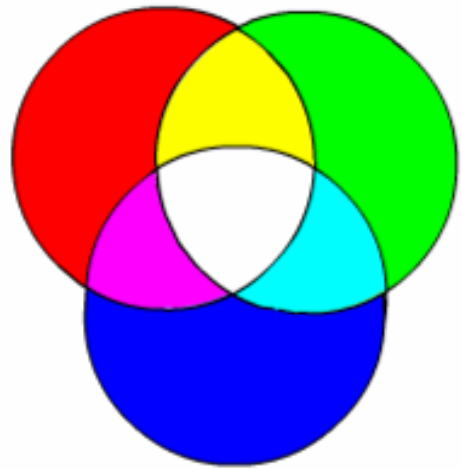

When all three cone types are stimulated one sees white.

How cones are distributed on the retina.

In the fovea

- 1) the # of each cone type is not equal. Usually red cones are most numerous and blue cones least numerous
- 2) the relative #'s vary from person to person
- 3) the cones of the same type form clusters

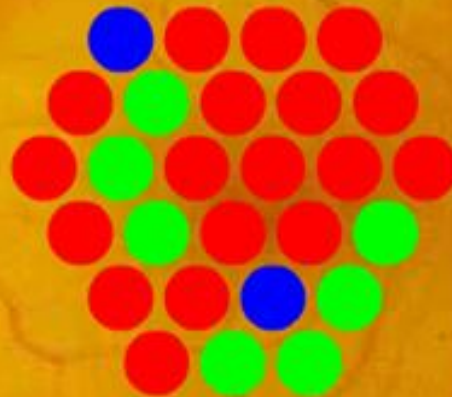

How cones are distributed on the retina.

The very center of the fovea has no blue type cones.

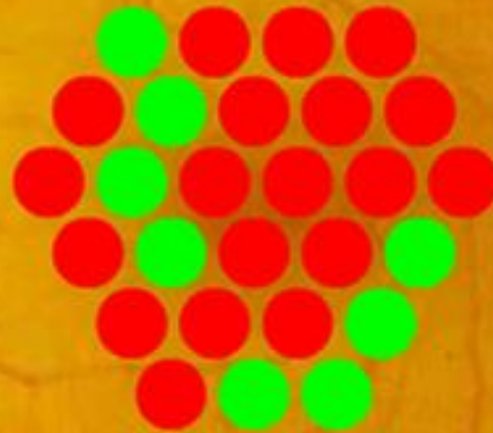

How cones are distributed on the retina.

As one moves away from the fovea

- 1) the #'s of cones drops and the #'s of rods increases
- 2) the size of both rods and cones increases and thus their density (# per square mm) decreases
- 3) cones become larger than rods.

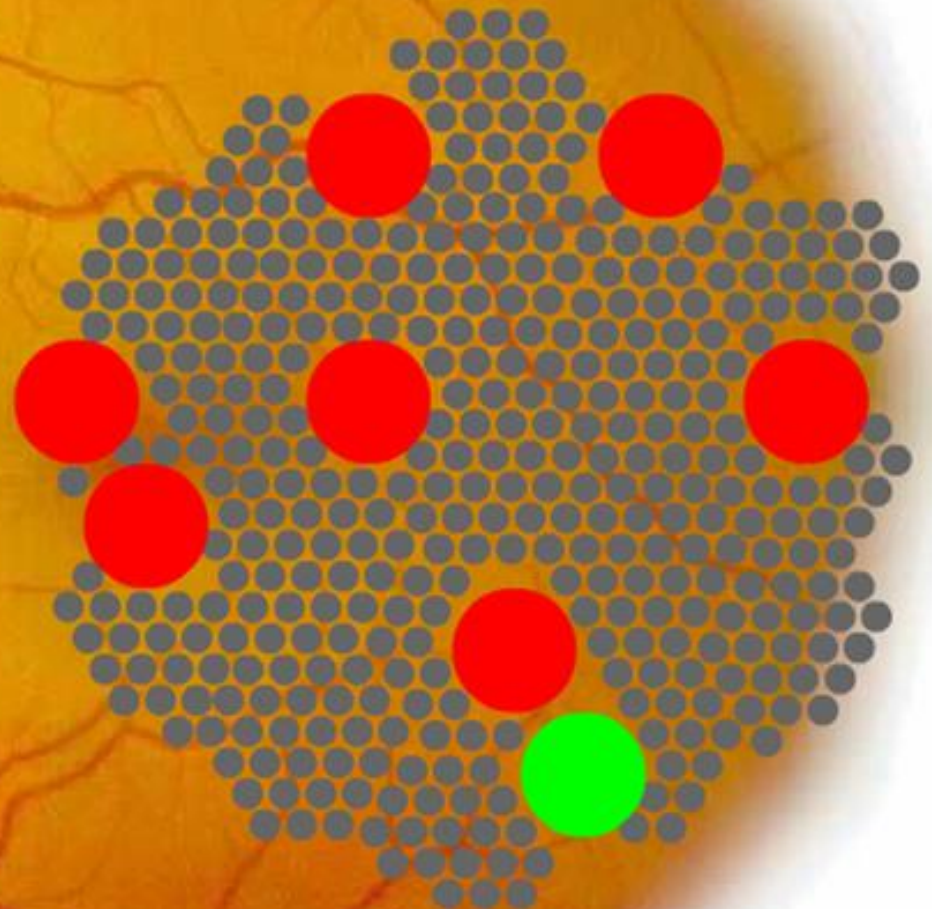

La percezione del colore nell'Uomo

a) 200 hues

The brain transforms the single wavelengths of light seen in rainbow into a color circle. Hues on opposite sides of the circle are complementary.



La percezione del colore nell'Uomo

a) 200 hues

The brain transforms the single wavelengths of light seen in rainbow into a color circle. Hues on opposite sides of the circle are complementary.

b) 20 levels of saturation

Combinations of two more wavelengths. When complementary wavelengths are combine equally one gets white.

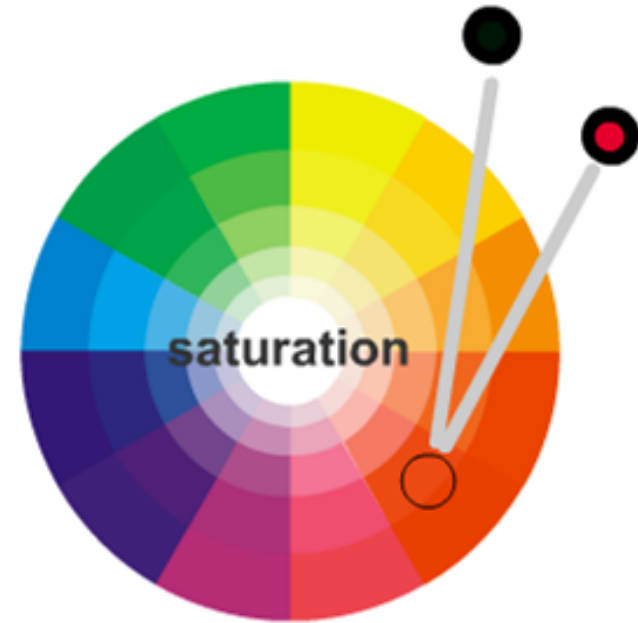

La percezione del colore nell'Uomo

a) 200 hues

The brain transforms the single wavelengths of light seen in rainbow into a color circle. Hues on opposite sides of the circle are complementary.

b) 20 levels of saturation

Combinations of two more wavelengths. When complementary wavelengths are combine equally one gets white.

c) 500 brightness levels

Any color on the circle can be made brighter or darker. But because brighter or darker colors are more difficult to distinguish, the circle becomes narrower.

brightness



500x200x20 = 2,000,000 gradations of color

La proiezione nel cervello

Images seen on one side are processed by the opposite side of the brain.

To do this, the ganglion cells on the medial side of each eye, from the middle of the fovea on, shown in **green**, cross at the **optic chiasm**.

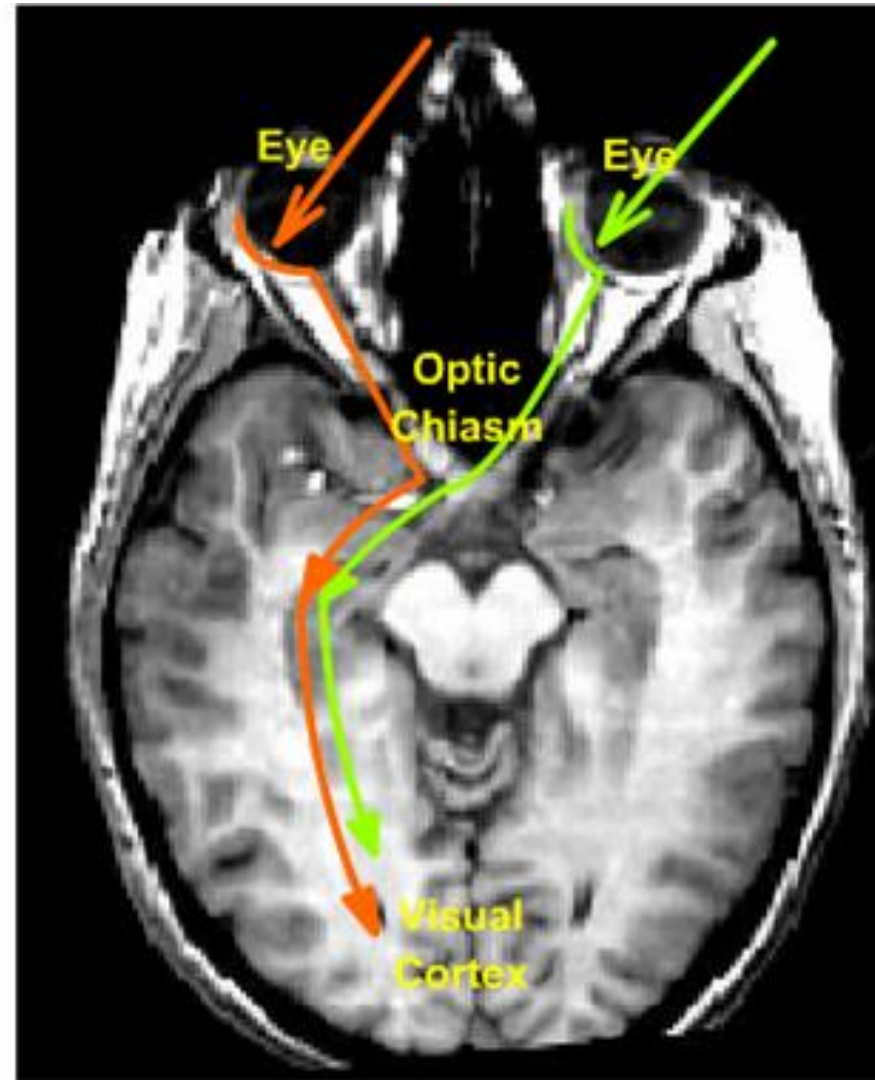

La proiezione sul corpo genicolato laterale (LGN – Lateral Geniculate Nucleus)

P (small) ganglion cells primarily from the fovea project to a part of the thalamus called the lateral geniculate nucleus (LGN)

M (large) ganglion cells, primarily from the peripheral retina, code **where** objects are & project both to LGN and several structures in the brainstem, including the superior colliculus (SC).

The SC causes the eye and head to turn to an interesting visual object: the “visual grasp reflex”.

The LGN sends information to visual cortex; information as to **what** an object is (P cells) and **where** it is (M cells).

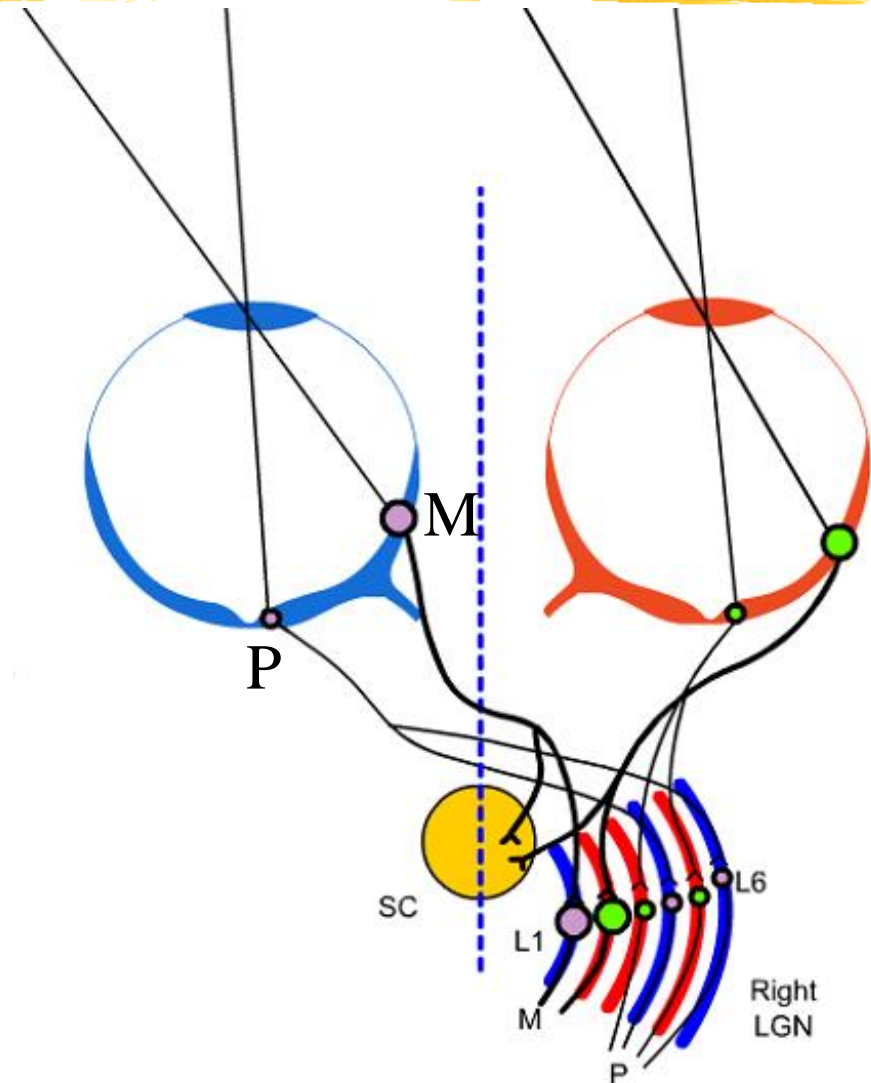

Localizzazione della corteccia visiva

To where in V1 does the LGN project?

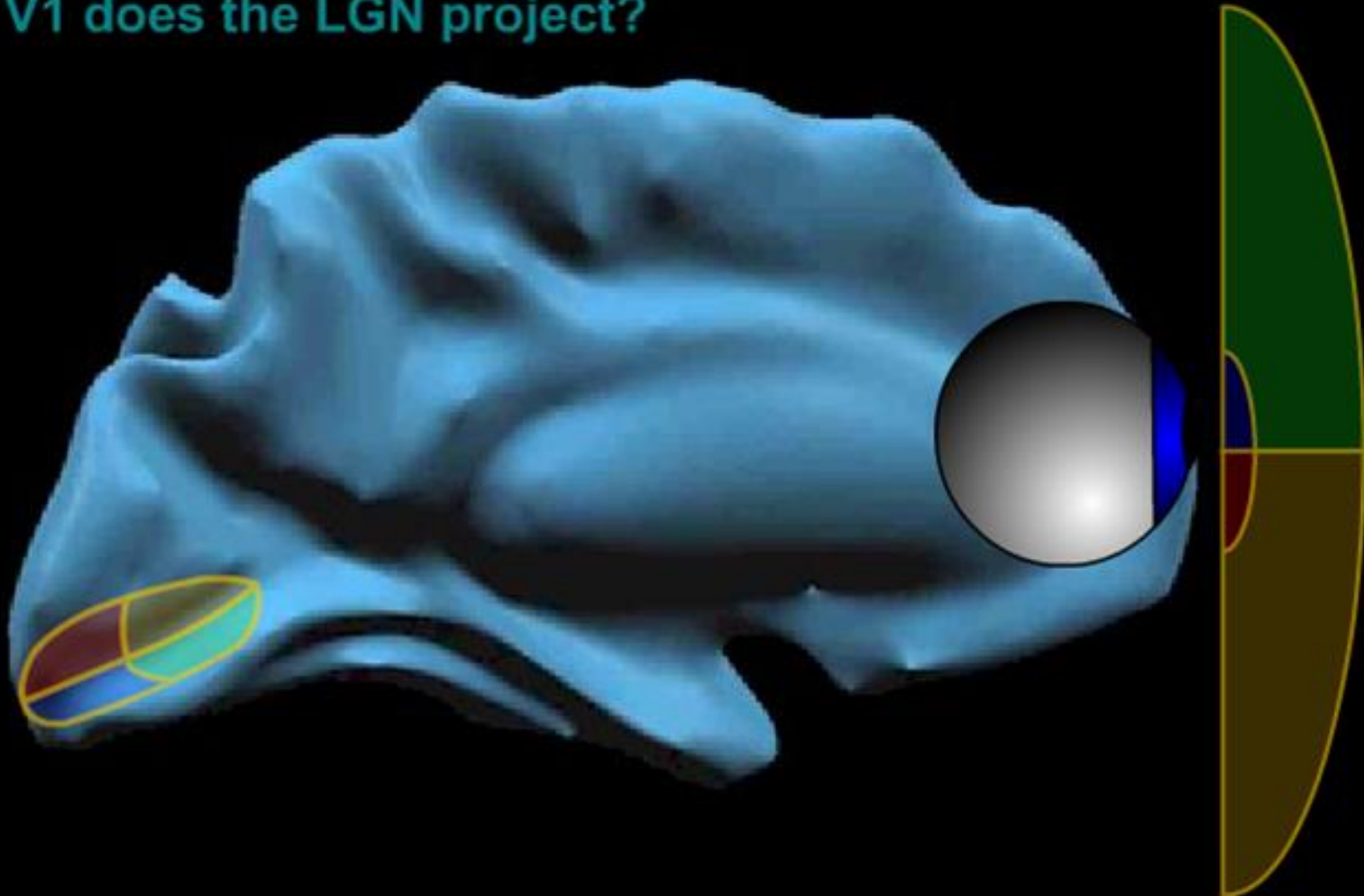

V1 contains 3 main types of cells

1. Layer 4c cells, whose receptive fields are the same as that of LGN & ganglion cell.

2. Simple cells with elongated receptive fields and thus maximally activated by a line of a particular orientation activating a particular region of the retina.

3. Complex cells whose receptive fields are similar to those of simple cells except the line can lie over a larger area of the retina (positional invariance) and they fire most to moving lines.

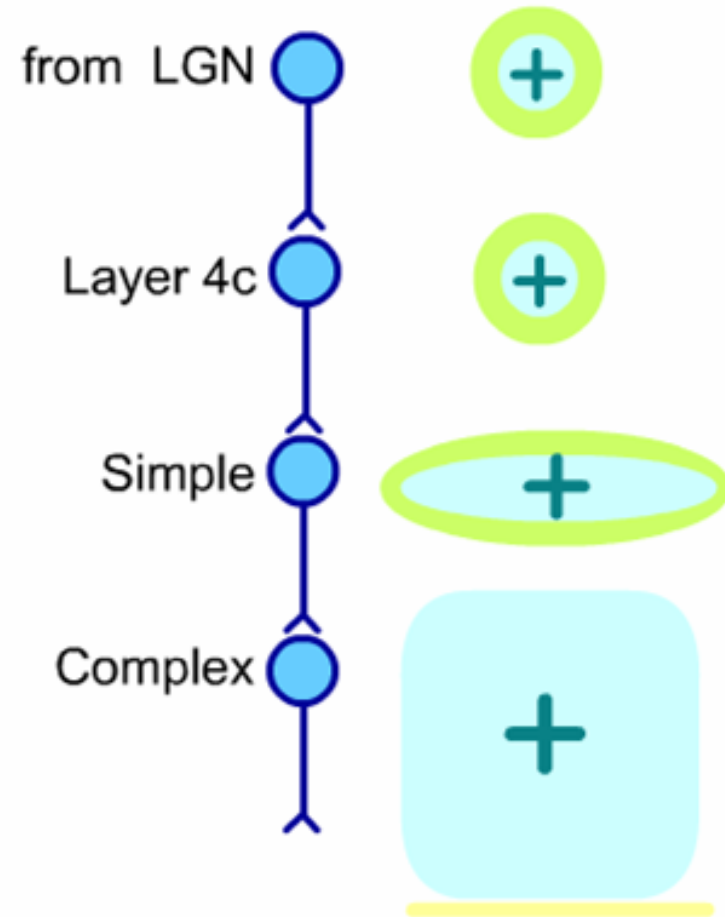

Le cellule semplici

Simple cells

Several ganglion cells, whose receptive fields lie along a common line, converge by way of the LGN onto a simple cell.

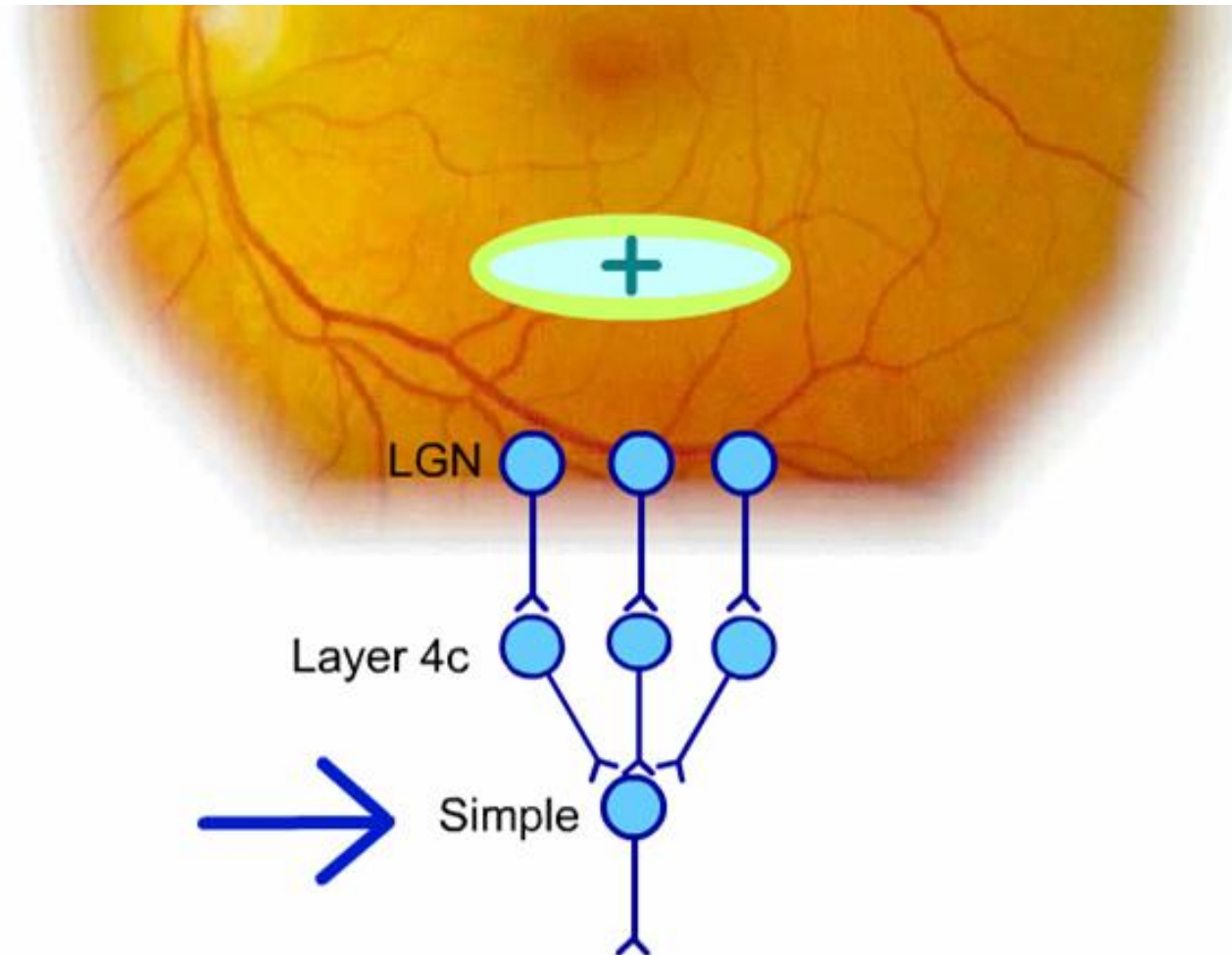

Le cellule complesse

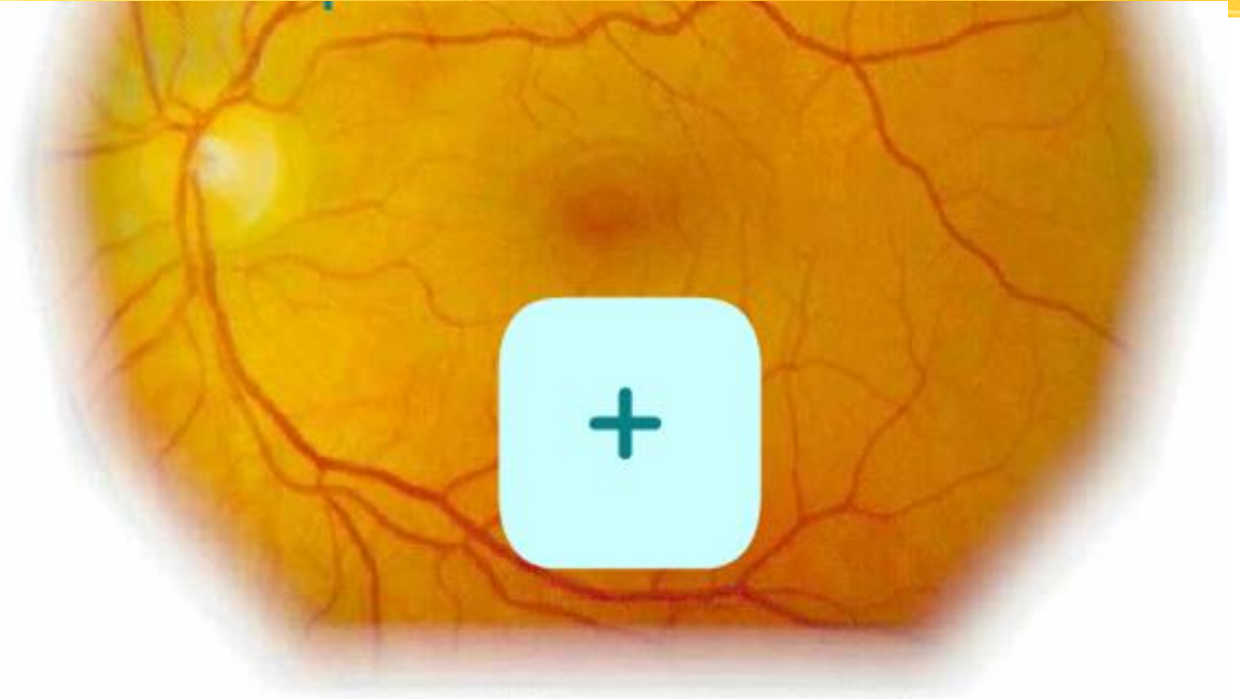

Complex cells: Several simple cells of the same orientation converge onto a complex cell.

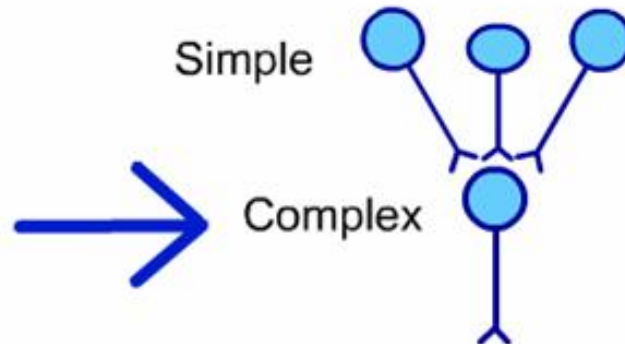

La percezione del movimento

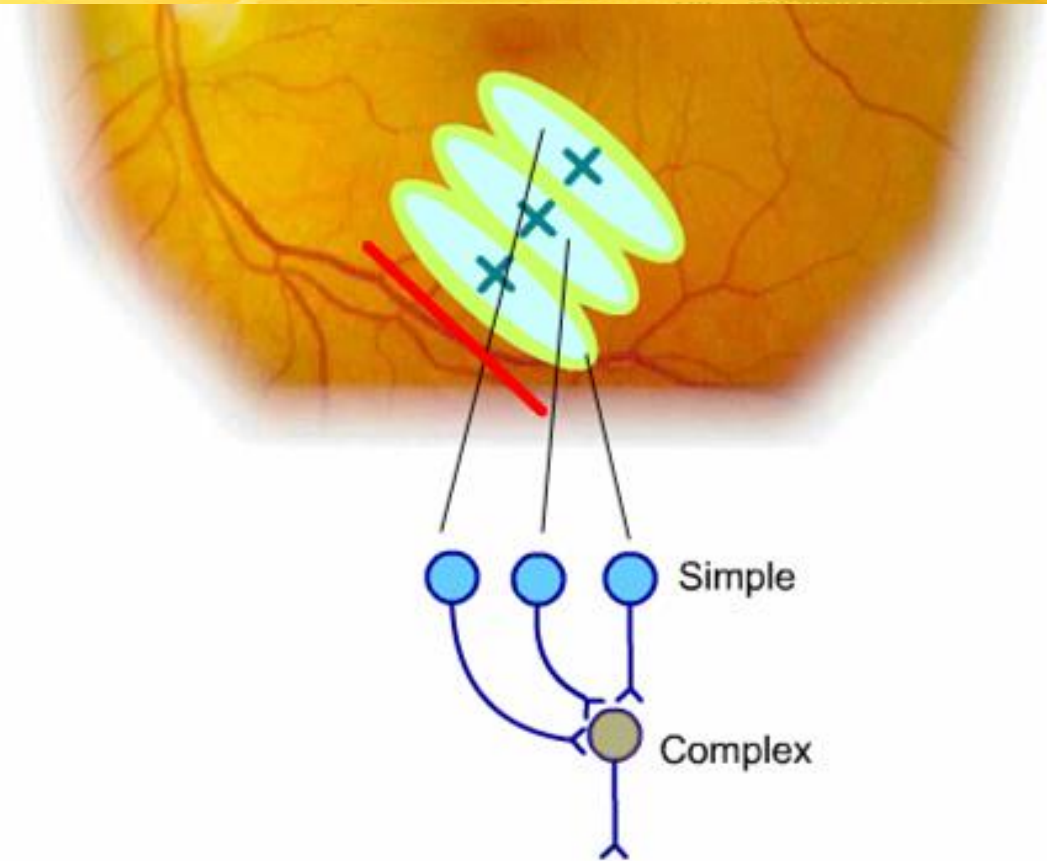

Recall that motion cells, in V1, sense motion of lines.

These cells are best tuned to lines moving perpendicular to the line's orientation.

The columnar organization of the primary visual cortex.

Each hypercolumn extracts the following features:

- A) Stereopsis**
- B) Colour**
- C) Orientation of line segments**

Note that this arrangement allows cells with similar receptive fields to be grouped together. This is an important organizing principle shared by all the cortex. Neurons like to be near their own kind. This minimizes the length and # of axons.

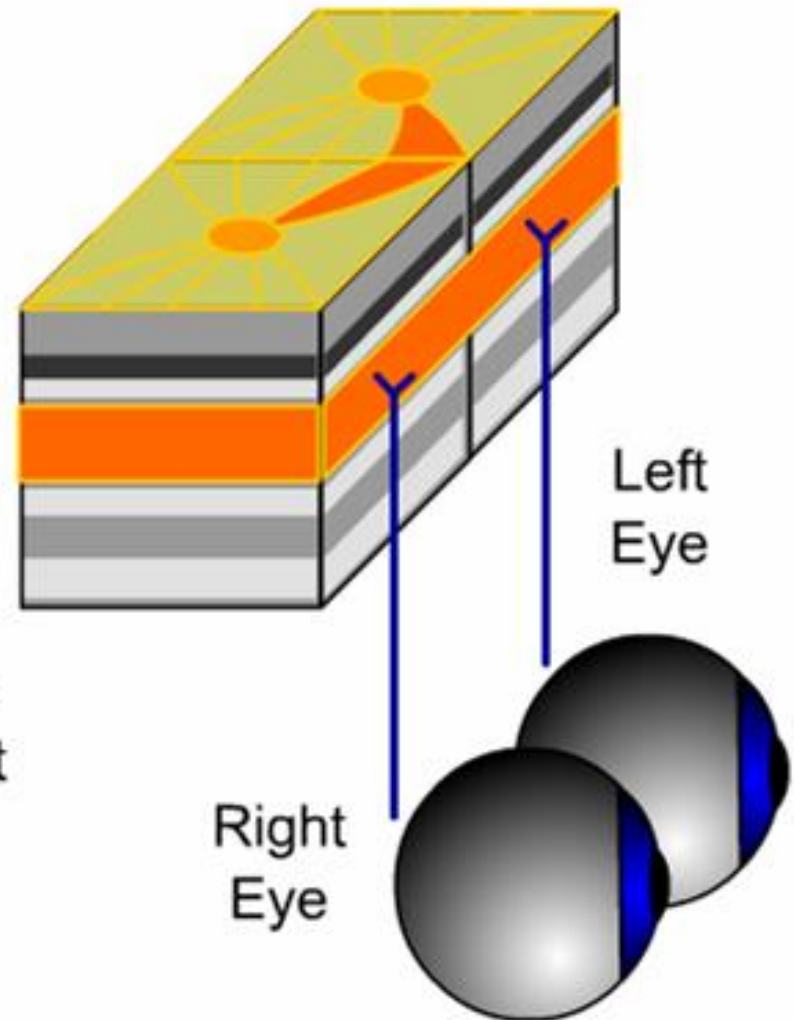

I movimenti oculari



There are 5 types of eye movements. Each

1) serves a unique function &

2) has properties particularly suited to that function.

1. *Saccades*

2. *Vergence*

3. *Pursuit*

4. *VOR*

5. *OKR*

I movimenti oculari

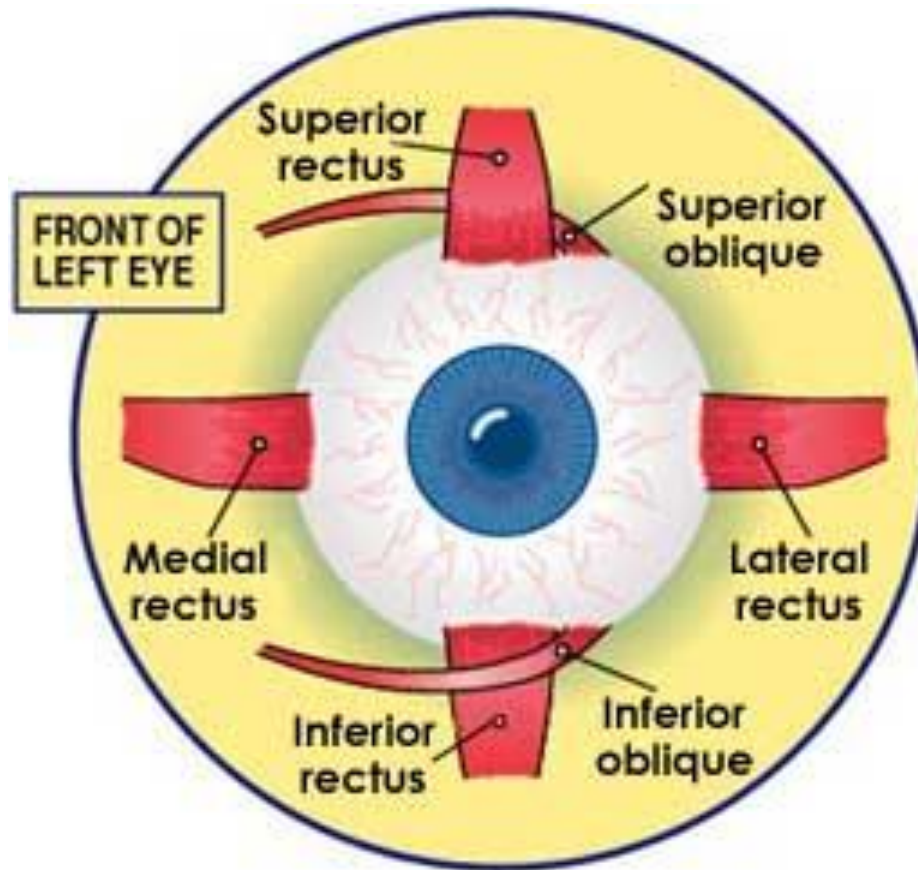

Eye Muscles

Types of Eye Movement



Saccades:

- Quick “jumps” that connect fixations
- Duration is typically between 30 and 120 ms
- Very fast (up to 700 degrees/second)
- Saccades are ballistic, i.e., the target of a saccade cannot be changed during the movement.
- Vision is suppressed during saccades to allow stable perception of surroundings.
- Saccades are used to move the fovea to the next object/region of interest.

Types of Eye Movement



Smooth Pursuit Eye Movements:

When an object moves, the image is kept still on the retina by means of a pursuit eye movement (e.g. tracking a moving ball or your finger).

- Smooth movement of the eyes for visually tracking a moving object
- Cannot be performed in static scenes (fixation/saccade behavior instead)

→ *prediction*

Types of Eye Movement



Vergence Eye Movements:

- Slow, smooth movements changing the vergence angle (the angle between the two viewing axes)
- Used for changing gaze from a near to a far object or vice versa
- Can take up to one second
- Execution is often interrupted if no thorough inspection of the object is required.

Vergenza



If you look (i.e. direct the foveas) from a far object to a near one, vergence eye movements are generated, convergence when looked from far to near and divergence when looking from near to far.

How do saccadic and vergence eye movements differ?

Notice that vergence movements are much slower than saccades. Also during saccades both eyes rotate in the same direction. During vergence, they rotate in opposite directions.

VOR (Vestibulo-Ocular Reflex)



If we move our head, an eye movement very similar to pursuit is elicited whose function is also to keep the image still on the retina.

However, in spite of the fact that the movement looks similar, it is generated by a different neural circuit, the vestibular ocular reflex (VOR).

The VOR responds much faster than the pursuit system. Notice that you can read a page of text while you shake your head quickly from side to side.

To activate the pursuit system, take a page of text and try reading it while you shake the page quickly from side to side.

Also unlike the pursuit system, the VOR does not need a visual stimulus.

It works in the dark. Rotate your head with your eyes closed.

Feel your eyes move with your finger tips.

VOR (Vestibulo-Ocular Reflex)



- Reflex eye movement that stabilizes images on the retina during head movement by producing an eye movement in the direction opposite to head movement, thus preserving the image on the center of the visual field
- since slight head movements are present all the time, the VOR is very important for stabilizing vision: patients whose VOR is impaired cannot read, because they cannot stabilize the eyes during small head tremors
- the VOR reflex does not depend on visual input and works even in total darkness or when the eyes are closed
- Latency of 14 ms (time between the head and the eye movement)

The Vestibulo-Ocular Reflex (VOR)

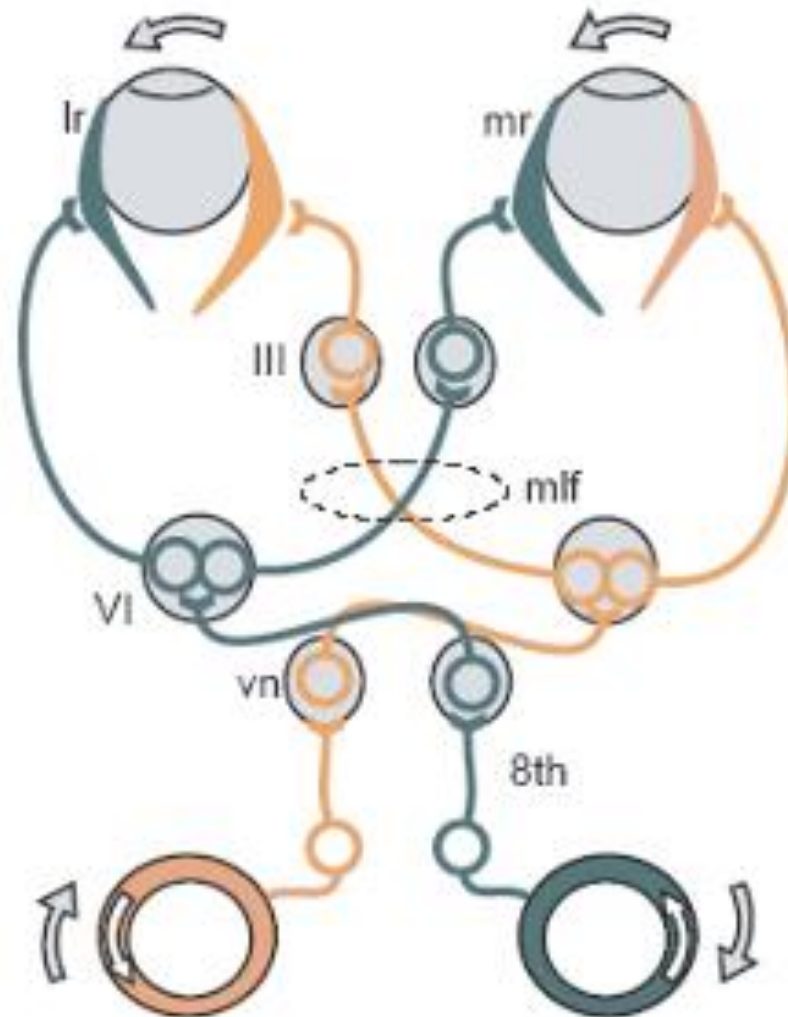

Vestibulo-ocular Reflex

Explain the neural mechanism for a horizontal VOR.

The direct path is a short reflex with 3 synapses.

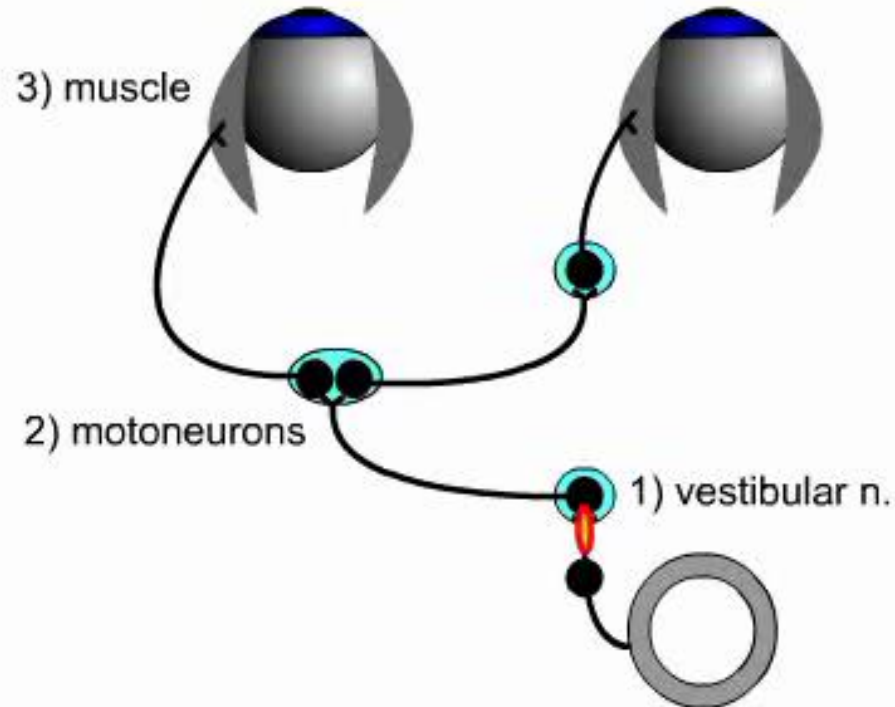

Vestibulo-ocular Reflex

Explain the neural mechanism for a horizontal VOR.

When the **head rotates rightward** the following occurs.

The right horizontal canal hair cells depolarize.

The right vestibular nucleus (VN) firing rate increases.

The motoneurons (in the right 3rd and left 6th nuclei) fire at a higher frequency.

The left lateral rectus (LR) extraocular muscle and the right medial rectus (MR) contract.

Both **eyes rotate leftward**.

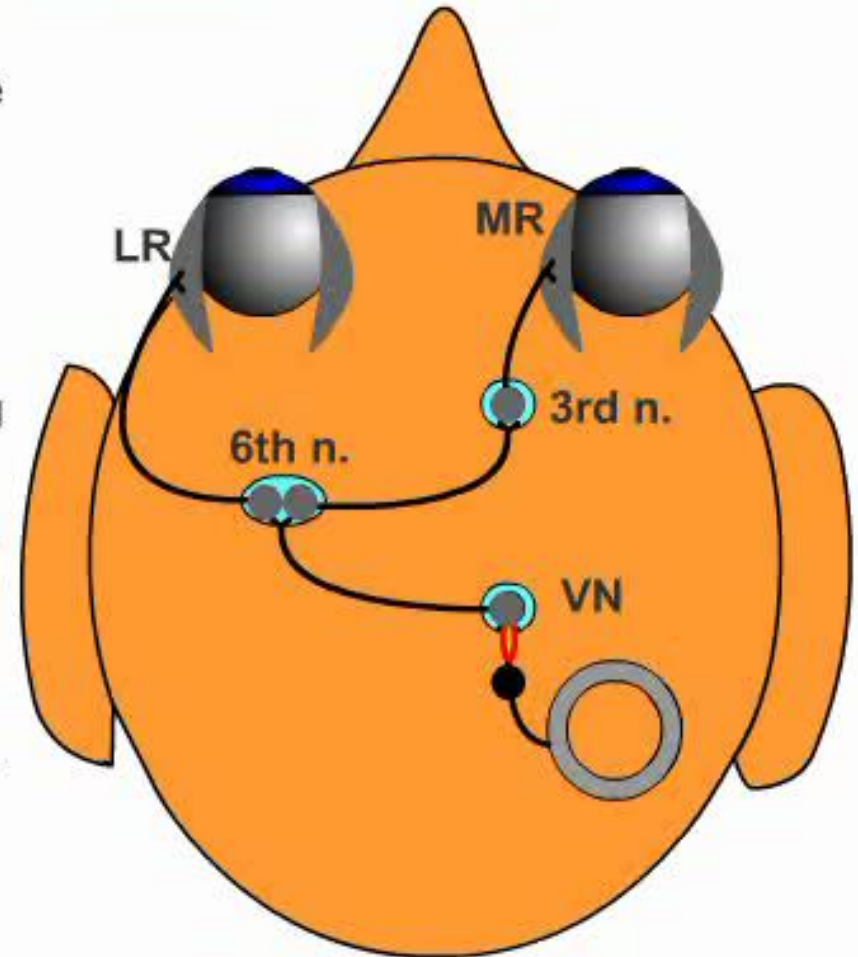

Vestibulo-ocular Reflex

Explain the neural mechanism for a horizontal VOR.

The VOR is a push-pull reflex.
Neurons on other side do the opposite.

When the **head rotates rightward** the following occurs.

The left horizontal canal hair cells hyperpolarize.

The left vestibular nucleus firing rate decreases.

Motor neurons in the left 3rd and right 6th nuclei fire at a lower frequency.

The left medial rectus and the right lateral rectus relax.

This helps the **eyes rotate leftward**.

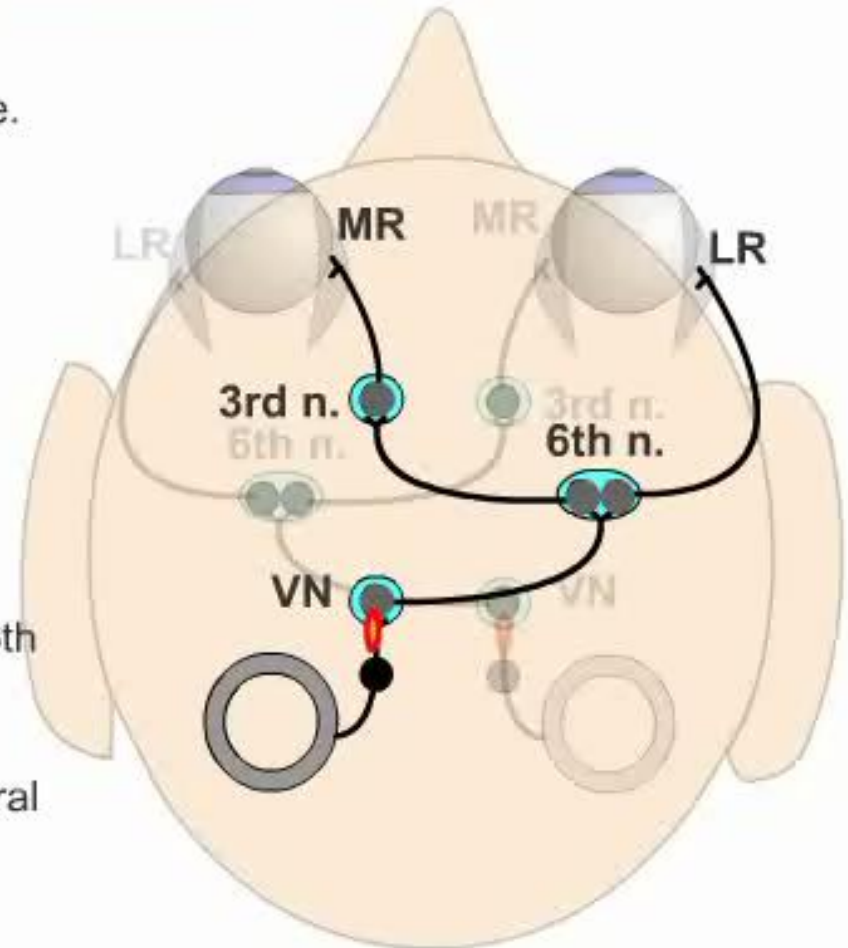

OKR (OptoKinetic Response)



The VOR does not work well for slow prolonged movements. In this case vision, through the optokinetic response (OKR), assists the VOR.

The OKR is activated when the image of the world slips on a large portion of the retina and produces a sense of self motion (e.g. when sitting in a car that is stopped and a car beside you starts to move, you sometimes feel like you are moving).

OKR (OptoKinetic Response)



- The optokinetic reflex allows the eye to follow objects in motion when the head remains stationary
- The OKR is activated when the image of the world slips on a large part of the retina
- This reflex is based on the visual information
- The latency is longer than in VOR

Other Eye Movements



Torsional Eye Movements:

- Rotation of the eye around the viewing axis
- Stabilization of visual scene by compensating body rotation (up to about 15 degrees)

Other Eye Movements



Fixations:

- The eye is almost motionless, for example, while reading a single, short word
- The information from the scene is almost entirely acquired during fixation
- Duration varies from 100-1000 ms, typically between 200-600 ms
- Typical fixation frequency is about 3 Hz
- Fixations are interspersed with saccades

Other Eye Movements



Tremor:

- Fast, low-amplitude (seconds of arc) eye-movement “jitter”
- Improves the perception of high spatial frequencies
- Prevents the fading of static images during fixations