



UIC Project EIRENE System Requirements Specification

Source:	GSM-R Operators Group
Date:	17 May 2006
Reference:	PSA167D006
Version:	15
Number of pages:	Cover + 136 pages

Important notice

This document is subject to further evolution and may therefore be used at the sole and entire responsibility of the organisation or entity deciding to do so.

The UIC is not liable for any consequence of any kind resulting from the use by third parties of the information extracted from this document.

PAGE LEFT INTENTIONALLY BLANK

Document History

Version	Date	Details
10.1	14 July 1998	All sections incorporated into one document CR 98-105.1 CR 98-106.1 CR 98-107.1 CR 98-108.1 rev 1 CR 98-109.1 CR 98-110.1 CR 98-111.1 CR 98-112.1 CR 98-113.1 CR 98-114.1 CR 98-115.1 CR 98-116.1 CR 98-117.1 CR 98-119.1 Editorial changes
10.2	5 August 1998	CR 98-118.1 CR 98-119.1 CR 98-120.1 CR 98-121.1
10.3	24 September 1998	CR 98-122.1 (rev 1) CR 98-123.1 (rev 1) CR 98-124.1 (rev 1) CR 98-125.1 (rev 1) CR 98-126.1 (rev 1) CR 98-127.1 (rev 1) CR 98-128.1 (rev 1) CR 98-129.1 CR 98-130.1 (rev 1) CR 98-131.1 (rev 1) CR 98-132.1 (rev 1) CR 98-133.1 CR 98-134.1 (rev 1) CR 98-135.1 (rev 1) CR 98-136.1 CR 98-137.1 CR 98-138.1 (rev 1) CR 98-139.1 CR 98-140.1 CR 98-141.1 CR 98-142.1 (rev 1) CR 98-143.1

Version	Date	Details
10.3 (cont)		CR 98-144.1 CR 98-145.1 CR 98-146.1 CR 98-147.1 CR 98-148.1 CR 98-149.1 CR 98-150.1 CR 98-151.1 CR 98-152.1 (rev 1) CR 98-157.1
11.0	22 December 1998	CR 98-153.1 CR 98-154.2 CR 98-155.2 CR 98-156.2 CR 98-160.2 CR 98-161-1 CR 98-162-1 CR 98-164.2 CR 98-165.2 CR 98-166.1 CR 98-167.2 CR 98-168-2 CR 98-169-4 CR 98-170-1 CR 98-171-1 CR 98-172-1 CR 98-173-1 CR 98-174-1 CR 98-175-1 CR 98-176-1 CR 98-177-1 CR 98-178-1 CR 98-179-1 CR 98-181-2 CR 98-182-1 CR 98-183-2 CR 98-184-3 CR 98-185-2 CR 98-186-1 CR 98-187-1 CR 98-188-1 CR 98-189-1 CR 98-190-1 CR 98-191-1

Version	Date	Details
12.0	20 December 1999	SCR 99-192.3 SCR 99-193.1 SCR 99-195.1 SCR 99-196.2 SCR 99-197.1 SCR 99-198.2 SCR 99-199.2 SCR 99-201.2 SCR 99-202.2 SCR 99-203.2 SCR 99-204.1 SCR 99-205.1 SCR 99-206.2 SCR 99-207.1 SCR 99-208.1 SCR 99-209.2 SCR 99-212.2 SCR 99-213.2 SCR 99-214.2 SCR 99-215.2 SCR 99-216.2 SCR 99-219.2 SCR 99-220.1 SCR 99-221.1 SCR 99-222.1 SCR 99-224.4 SCR 99-228.1 SCR 99-229.2 SCR 99-230.3 SCR 99-231.1 SCR 99-232.1 SCR 99-233.1 SCR 99-237.1 SCR 99-239.1 SCR 99-240.1 SCR 99-242.2

Version	Date	Details
13.0	15 December 2000	SCR 99-241.1 SCR 00-243.1 SCR 00-245.1 SCR 00-246.1 SCR 00-247.1 SCR 00-248.2 SCR 00-249.4 SCR 00-250.2 SCR 00-251.4 SCR 00-252.1 SCR 00-253.1 SCR 00-254.1 SCR 00-255.4 SCR 00-256.1 SCR 00-257.4 SCR 00-258.1 SCR 00-259.2 SCR 00-260.2 SCR 00-261.1 SCR 00-262.3 SCR 00-263.2 SCR 00-264.2 SCR 00-265.1 SCR 00-266.1 SCR 00-267.2 SCR 00-268.2 SCR 00-269.1 SCR 00-270.1 SCR 00-272.1 SCR 00-273.1 SCR 00-274.1 SCR 00-275.2 SCR 00-276.2 SCR 00-277.1 SCR 00-278.2 SCR 00-279.1 SCR 00-280.1 SCR 00-281.1

Document History

Version	Date	Details
14.0	21 October 2003	O-9004 (SCR 01-284.2) O-9005 (SCR 01-285.1) O-9006 (SCR 01-286.1) O-9007 (SCR 01-287.1) O-9008 (SCR 01-288.1) O-9009 (SCR 01-289.1) O-9010 (SCR 01-290.1) O-9011 (SCR 01-291.1) O-9012 (SCR 01-294.1) O-9013 (SCR 01-295.1) O-9014 (SCR 01-296.1) O-9015 (SCR 02-299.1) O-9016 (SCR 02-300.1) O-9017 (SCR 02-303.1)

Version	Date	Details
15.0	29 March 2006	O-9019 O-9020 O-9021 O-9022 O-9023 O-9033 O-9036 O-9037 O-9038 O-9039 O-9040 O-9041 O-9047 O-9049 O-9050 O-9051 O-9052 O-9053 O-9055 O-9056 O-9060 O-9062 O-9063 O-9064 O-9065 O-9066 O-9067 O-9068 O-9069 O-9070 O-9071 O-9073 O-9074 O-9075 O-9080 O-9081 O-9082 O-9085 O-9088 O-9089 O-9096 O-9097 O-9099

Document History

Version	Date	Details
15	17 May 2006	Approved by GSM-R Operators Group, Functional Group and Industry Group

PAGE LEFT INTENTIONALLY BLANK

List of contents

Important notice	1
Document History	3
List of abbreviations	15
List of definitions	19
1 Introduction	25
1.1 General	25
1.2 Scope	25
1.3 Applicability	26
1.4 System overview	27
1.5 Structure of the specification	32
2 Network requirements	35
2.1 Introduction	35
2.2 GSM teleservices	35
2.3 GSM bearer services	36
2.4 GSM supplementary services	37
2.5 Railway specific services	38
2.6 Alerting duration	38
3 Network configuration	39
3.1 Introduction	39
3.2 Coverage	39
3.3 Handover and cell selection	40
3.4 Call setup time requirement	40
3.5 Frequency band and channel arrangements	41
3.6 DTMF tones and signals	41
3.7 Termination of VGCS/VBS calls	41
3.8 Muting and unmuting for VGCS calls	41
4 Mobile equipment core specification	43
4.1 Introduction	43
4.2 Radio interface aspects	44
4.3 Services and facilities	45
4.4 Core MMI requirements	49
4.5 Core environmental requirements	50
5 Cab radio	55
5.1 Introduction	55
5.2 System components	55
5.3 Driver call-related functions	56
5.4 MMI functions	58
5.5 Handling of calls	59
5.6 Other Cab radio functions	63
5.7 Environmental and physical	65

5.8	Cab radio interfaces to on-train systems	67
5.9	Train borne recorder	67
5.10	ERTMS/ETCS interface	67
5.11	Public Address interface	68
5.12	UIC Intercom	68
5.13	Driver's Safety Device	68
5.14	Other interfaces	68
5.15	Train Interface Unit (TIU)	68
5A	Handling of calls	71
5A.1	Call arbitration table	71
5A.2	Call termination of outgoing calls table	75
5A.3	Call termination of incoming calls table	76
6	General purpose radio	77
6.1	Introduction	77
6.2	System components	77
6.3	General purpose radio functions	77
6.4	Environmental and physical	78
7	Operational radio	81
7.1	Introduction	81
7.2	System components	81
7.3	Operational radio functions	81
7.4	Shunting radio requirements	82
7.5	Environmental and physical	82
8	Controller equipment specifications	85
8.1	General	85
8.2	Termination of VGCS/VBS calls	85
8.3	Muting and unmuting for VGCS calls	85
9	Numbering plan	87
9.1	General	87
9.2	Numbering plan requirements	87
9.3	Numbering plan limitations	89
9.4	Types of numbers	89
9.5	Use of National EIRENE Numbers	90
9.6	Use of International EIRENE Numbers	97
9.7	Use of MSISDN numbers	98
9.8	Use of Short Dialling Codes	98
9.9	Use of group addresses	99
9.10	Access to external networks	100
9.11	Calls from external networks to the GSM-R network	101
9A	Function Codes	103
9B	Numbering plan overview	105

10	Subscriber management	107
10.1	Introduction	107
10.2	Allocation of priorities	107
10.3	Access classes	108
10.4	Closed user groups	109
10.5	Network selection	109
10.6	Cell broadcast message identifiers	109
10.7	Encryption and authentication	110
11	Functional numbering and location dependent addressing	111
11.1	Introduction	111
11.2	Ground-train addressing	111
11.3	Functional numbering	111
11.4	Re-establishment of functional number correlation	114
11.5	Presentation of functional identities	115
11.6	Inter EIRENE network interfacing	116
11.7	Location dependent addressing	116
11.8	Calls from external networks to the EIRENE network	117
12	Text messaging	119
12.1	Introduction	119
12.2	System requirements	119
13	Railway emergency calls	121
13.1	Introduction	121
13.2	Provision of Railway emergency calls	121
13.3	Initiation of Railway emergency calls	121
13.4	Receipt of Railway emergency calls	122
13.5	Confirmation of Railway emergency calls	122
14	Shunting mode	125
14.1	Introduction	125
14.2	System requirements: Operational Radio	125
14.3	System requirements: Cab radio	128
14.4	System requirements: Operational radio and Cab radio	129
14.5	Numbering plan	129
14.6	Control of shunting group membership	130
14.7	Link assurance signal	130
15	Direct mode	131
15.1	Introduction	131
15.2	System requirements	131
A	References	133
A.1	List of normative references	133
A.2	List of informative references	135

PAGE LEFT INTENTIONALLY BLANK

List of abbreviations

3GPP	Third Generation Partnership Project
AoC	Advice of Charge
ARFCN	Absolute Radio Frequency Channel Number
ATC	Automatic Train Control
BOIC	Barring of Outgoing International Calls
BSC	Base Station Controller
BSS	Base Station System
BTS	Base Transceiver Station
CCBS	Completion of Calls to Busy Subscribers
CFU	Call Forwarding Unconditional
CLI	Calling Line Identity
CLIP	Calling Line Identity Presentation
CLIR	Calling Line Identification Restriction
CN	Coach Number
CoLP	Connected Line Identification Presentation
CoLR	Connected Line Identification Restriction
COTS	Commercial Off-the-Shelf
CT	Call Type
CUG	Closed User Group
CW	Call Waiting
DM	Direct Mode
ECT	Explicit Call Transfer
EIRENE	European Integrated Railway Radio Enhanced Network
eMLPP	Enhanced Multi-Level Precedence and Pre-emption
EN	Engine Number
ENAN	EIRENE Network Access Number
ERTMS	European Rail Traffic Management System
ETCS	European Train Control System
ETSI	European Telecommunications Standards Institute
FC	Function Code
FFFIS	Form Fit Functional Interface Specification
FFFS	Form Fit Functional Specification
FIS	Functional Interface Specification
FN	Functional Number
GCR	Group Call Register

GGSN	Gateway GPRS Support Node
GLN	Group Location Number
GPRS	General Packet Radio Service
GSM	Global System for Mobile communications
GSM-R	GSM - Railway
HLR	Home Location Register
IC	International Code
IEC	International Electrotechnical Commission
IFN	International Functional Number
IMSI	International Mobile Subscriber Identity
ISDN	Integrated Services Digital Network
ITU	International Telecommunications Union
ITU-T	International Telecommunications Union – Telecommunications
LN	Location Number
MAP	Mobile Application Part
ME	Mobile Equipment
MMI	Man-Machine Interface
MO/PP	Mobile Originated/Point-to-Point (short message)
MORANE	MOBILE radio for RAILway Networks in Europe
MPTY	Multi ParTY service
MS	Mobile Station
MSC	Mobile Services Centre
MSISDN	Mobile Station International ISDN Number
MT	Mobile Termination
MT/PP	Mobile Terminated/Point-to-Point (short message)
MTLN	Maintenance Team Location Number
NFN	National Functional Number
NSS	Network Sub-System
OMC	Operation and Maintenance Centre
PA	Public Address
PABX	Private Automatic Branch Exchange
PDP	Packet Data Protocol
PLMN	Public Land Mobile Network
PTT	Push-To-Talk
QoS	Quality of Service

List of abbreviations

RBC	Radio Block Centre
SA	Service Area
SGSN	Serving GPRS Support Node
SIM	Subscriber Identity Module
SMS	Short Message Service
STLN	Shunting Team Location Number
TBD	To Be Determined
TCLN	Train Controller Location Number
TDMA	Time Division Multiple Access
TN	Train Number
TRX	Transceiver
TS	Technical Specification
UA	Unnumbered Acknowledge
UIC	Union Internationale des Chemins de Fer
UIN	User Identifier Number
Um	GSM air interface
UN	User Number
USSD	Unstructured Supplementary Service Data
UUS1	User-to-User Signalling type 1
VBS	Voice Broadcast Service
VGCS	Voice Group Call Service
VLR	Visitor Location Register

PAGE LEFT INTENTIONALLY BLANK

List of definitions

Balise

A passive or active device normally mounted in proximity to the track for communications with passing trains. A standard for passive balises has been devised within the EUROBALISE project.

Broadcast call

A call made to all members of a pre-defined group within a local geographical area. Only the initiator of the call may talk with all other group members listening only.

Cab radio

The radio and associated user and other interfaces installed in the cab of a locomotive and for use principally by the locomotive driver. Definition also includes those radios supporting ATC.

Call type

A prefix used to identify the User Number dialled.

Chief conductor

A member of the train crew with overall responsibility for passenger related Railway activities on-board the train.

Coach number

A number assigned to an item of rolling stock on a permanent basis. The coach number may form a component of a functional number used to address users/systems on an item of rolling stock.

Controller

An individual responsible for the conduct of some aspect of train operations (also known as dispatcher). For the purposes of this specification the following functional roles of controllers are defined:

- primary controller;
- secondary controller;
- traffic controller;
- power supply controller.

Dependent upon local circumstances, a number of functional roles can be carried out by a single controller or a single functional role can be carried out by a number of controllers.

Direct mode

The term for back-to-back or set-to-set radio communications without the use of any ground infrastructure.

Driver safety device

An on-train system which monitors the alertness of the driver and provides warning and alarms to other systems as appropriate.

EIRENE network

An EIRENE network is a railway telecommunications network, based on the ETSI GSM standard, which complies with all related mandatory requirements specified in the EIRENE FRS and SRS. An EIRENE network may also include optional features and these shall then be implemented as specified in the EIRENE FRS and SRS. The EIRENE network excludes terminals.

EIRENE Network Access Number

A number dialled as an access code to allow use of functional numbers not compliant with the ITU-T Rec E.164.

EIRENE system

An EIRENE system is a railway telecommunications system based on the ETSI GSM standard, which complies with all related mandatory requirements as specified in the EIRENE FRS and SRS. An EIRENE system may also include optional features and these shall then be implemented as specified in the EIRENE FRS and SRS. The EIRENE System includes terminals.

Engine number

A number assigned to an item of traction stock on a permanent basis. The engine number may form a component of a functional number used to address users/systems on an item of traction stock.

Fiche

A UIC fiche or leaflet is a document adopted by UIC members. Statements within the fiche may comprise specifications which are binding on UIC members ('obligatory' specifications) or optional ('recommended' specifications). The existing track-to-train radio standard is contained within UIC fiche 751-3. It is envisaged that the EIRENE standard will be covered by a new UIC fiche, 751-4.

Functional addressing/numbering

A term used to describe the process of addressing a call using a number representing the function a user is performing, rather than a number identifying the user's terminal equipment.

Functional identity

The full alphanumeric description of the function performed by a called or calling party within the functional numbering scheme, identifying them by function or role rather than by a specific item of radio equipment or user subscription. The functional identity can include characters and/or numbers.

Functional number

The full number used within the functional addressing scheme to contact an end user/system by function or role rather than by a specific item of radio equipment or user subscription.

General purpose radio

A standard GSM radio based closely on commercially available units for general use.

Group call

A call made to all members of a pre-defined group within a local geographical area. Only one member of the group may talk at any instant with all other group members listening only.

Handover

The process by which connection between the GSM mobile and the GSM network is maintained as the mobile moves from area to area, by passing communication channel control from one base station to another or between different channels in one cell.

High speed line

A section of route forming part of the European High Speed Rail Network and any additional routes specified as such by national administrations.

Link assurance signal

A form of unidirectional signalling transmitted periodically or constantly from one radio to another to allow the receiving user to detect a break in radio transmission during critical manoeuvres (eg during shunting).

Location dependent addressing

A term used to describe the process of addressing a particular function (typically a controller) based on the current location of the user (typically a train).

Multi-party call

A voice communication method whereby a number of parties defined by the call initiator may participate in the call. All parties may talk simultaneously.

Multiple driver communications

A term used to describe communications between the drivers of each active cab in a train comprising multiple traction vehicles.

Operational communications

These are railway communications directly concerned with train movements or train operation. For example controller-driver communications.

Operational radio

A handheld radio suitable for use by people involved in railway operations (eg shunting team members).

Power supply controller

A controller responsible for the management of the traction power supply.

Primary controller

The location and direction of movement of any particular train permits the unique identification of a Primary Controller. The Primary Controller is currently the co-ordinator of train emergency calls. The Primary Controller is normally responsible for the operation of a designated area of track. The exact responsibilities of the Primary Controller are determined on a national basis.

Radio Block Centre

An ERTMS/ETCS term referring to a centralised safety unit to establish and control train separation using radio as the train to ground communication medium.

Railway Access Code

A prefix used to identify an EIRENE network outside the network the calling party is operating in.

Railway emergency call

A high priority call for informing drivers, controllers and other concerned personnel of a level of danger requiring all Railway movements in a pre-defined area to stop. Two types of Railway emergency calls are defined:

- Train emergency calls (for Railway emergencies whilst not involved in Shunting operations).
- Shunting emergency calls (for Railway emergencies whilst involved in Shunting operations).

Roaming

The use of a mobile on any communications network other than the user's home network.

Routing database

The database that contains the registered relationships between the functional number and the MSISDN.

Secondary controller

A Secondary Controller is a train controller who holds responsibility for the safe running of trains on a designated area of track (e.g. a signaller). Secondary Controllers require the facility to communicate with trains in all situations in order to perform their function. The split of responsibilities between Primary Controllers and Secondary Controllers is determined on a national basis.

Shunting emergency call

A Railway emergency call used to instruct shunting teams to cease shunting movements immediately.

Shunting team

A group of people manoeuvring trains in order to change their composition. Communications for shunting are particularly critical when a driver at the front of a train is pushing it backwards towards buffers or other potential obstructions. In this case a lookout is often required to report progress to the driver.

Stock number

A number assigned to an item of traction or rolling stock on a permanent basis. A stock number may form a component of a functional number used to address users/systems on an item of traction or rolling stock.

Support communications

These are railway communications which are not directly concerned with train movements or train operation. For example such communications might involve the passage of catering, maintenance or timetable information.

Traffic controller

A controller who has responsibility for the scheduling of trains and the 'flow' of trains over the network. For example, traffic control personnel are responsible for such activities as holding connecting services and minimising disruption to the timetable. The traffic control function has no formal safety responsibility.

Train control system (TCS)

The process by which the movement of a train is influenced without any action by the driver. For the purposes of this specification, reference to the train control system also encompasses automatic train protection, automatic train operation and in-cab signalling.

Train controller

A controller who has responsibility for the safe movement of trains.

Train number

A number given to a train by operational staff for a particular journey. A train number may form a component of functional number used to address users/systems on a train.

Tromboning

Tromboning may occur when a call is placed to a roaming mobile in the same country as the call originator. Tromboning is the term given to the routing of a call via the mobile's home country and back. This is obviously undesirable.

User number

The entry in a routing database. It consists of two parts: the User Identifier Number and the Functional Code.

1 Introduction

1.1 General

- 1.1.1 This specification has been developed within UIC Project EIRENE. It specifies a digital radio standard for the European railways. It forms part of the specification for technical interoperability. (I)

1.2 Scope

- 1.2.1 The EIRENE System Requirements Specification defines a radio system satisfying the mobile communications requirements of the European railways [EIRENE FRS]. It encompasses ground-train voice and data communications, together with the ground-based mobile communications needs of trackside workers, station and depot staff and railway administrative and managerial personnel. (I)
- 1.2.2 Figure 1-1 shows how the EIRENE system is covered in this specification, by associating each element of the system with its corresponding section number(s). References specifying the main interfaces are also cited, and are detailed more extensively in Appendix A. (I)

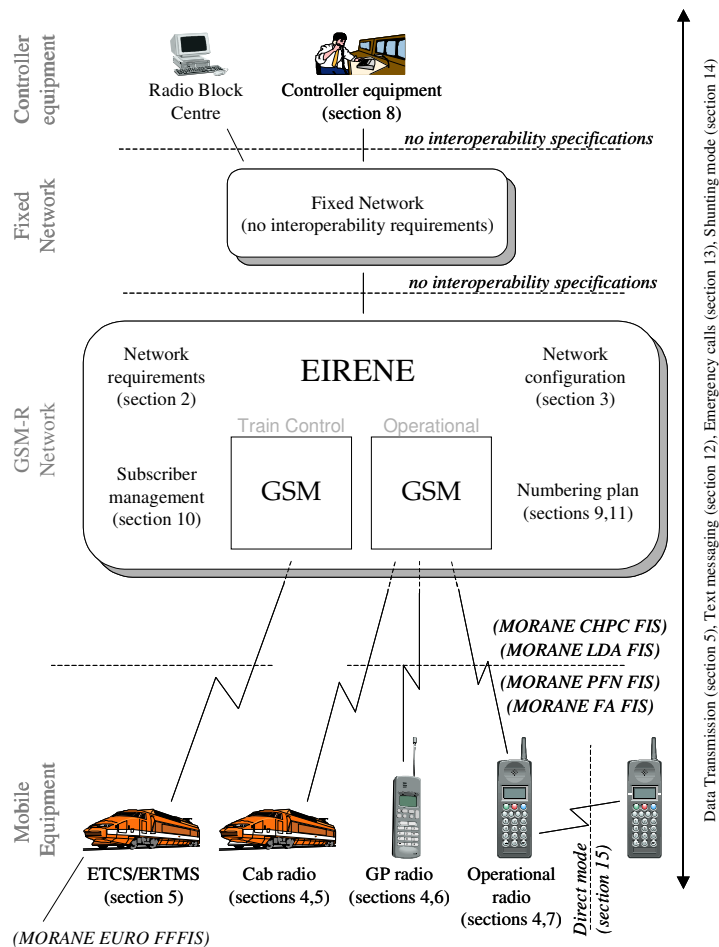

PFN = Presentation of Functional Numbers
 CHPC = Confirmation of High Priority Calls
 MORANE CHPC FIS
 MORANE LDA FIS
 MORANE PFN FIS
 MORANE FA FIS
 MORANE EURO FFFIS
 LDA = Location Dependent Addressing
 FA = Functional Addressing
 EURO = EURORADIO

Figure 1-1: Layout of EIRENE specifications and details of interfaces

1.2.3 The application of this specification will ensure interoperability for trains and staff crossing national or other borders between systems. It also intends to provide manufacturing economies of scale wherever practical. (I)

1.3 Applicability

1.3.1 The EIRENE System Requirements Specification defines the set of requirements which a railway radio system shall comply with in order to ensure interoperability between national railways. (I)

- 1.3.2 The EIRENE Functional Requirements Specification [EIRENE FRS] specifies the functional requirements for EIRENE. (I)
- 1.3.3 The specification distinguishes between requirements affecting a railway's network infrastructure, onto which mobiles will roam, and the requirements concerning mobiles which may be used in any EIRENE compliant network. (I)
- 1.3.4 The statements made in the specification are assigned to one of three categories: (I)
- Mandatory (indicated by '(M)' at the end of the paragraph). It is mandatory that each railway meets these specifications where interoperability on lines, or equipment interoperability, is required.
 - Optional (indicated by '(O)' at the end of the paragraph). Whilst not being mandatory for interoperability, when the option is selected, the method defined in the SRS and FRS by which such features are implemented becomes mandatory, both to provide a consistent service and to present a recognised and agreed standard to manufacturers in order to obtain economies of scale in development and manufacture.
 - Information (indicated by '(I)' at the end of the paragraph). These are statements intended to provide explanatory notes.

1.4 System overview

1.4.1 Extent of specification

- 1.4.1.1 The system is based on the ETSI GSM standard. To meet additional functionality and performance requirements, this standard is to be supplemented by: (I)
- the following GSM services:
 - voice broadcast service;
 - voice group call service;
 - enhanced multi-level precedence and pre-emption;
 - General Packet Radio Service (GPRS);
 - railway specific applications:
 - exchange of number and location information between train and ground to support functional and location dependent addressing;
 - emergency calls;
 - shunting mode;
 - multiple driver communications;
 - direct mode facility for set-to-set operation;
 - railway specific features, network parameters and standards;
 - link assurance signal;

- calling and connected line presentation of functional identities;
- cab radio, man-machine and other interfaces;
- environmental specifications;
- controller position functional specifications;
- system configuration (numbering plans, priority levels, subscriber details, closed user groups, etc).

1.4.1.2 The scope of the specification is shown in figure 1-2, showing the hierarchy of the GSM, and railway features to be implemented. (I)

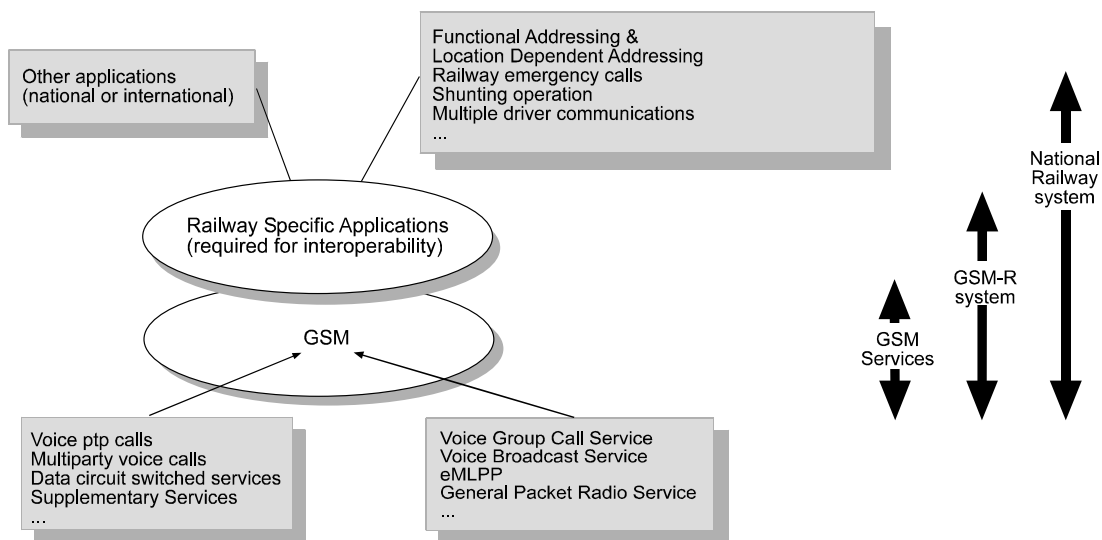

Figure 1-2: Scope of the GSM-R system with reference to functionality provided by GSM

1.4.1.3 A list of ETSI and 3GPP specifications is provided in the normative references section of this document. (I)

1.4.1.4 Compliance to the list of normative documents is mandatory for all of the GSM services necessary to provide the functionality specified in the [EIRENE FRS]. (M)

1.4.1.5 Later releases of these specifications may be used, providing that the system is backwards-compatible with the versions listed. (I)

1.4.2 Outline architecture

1.4.2.1 The system is based on the GSM architecture which is summarised in figure 1-3. (I)

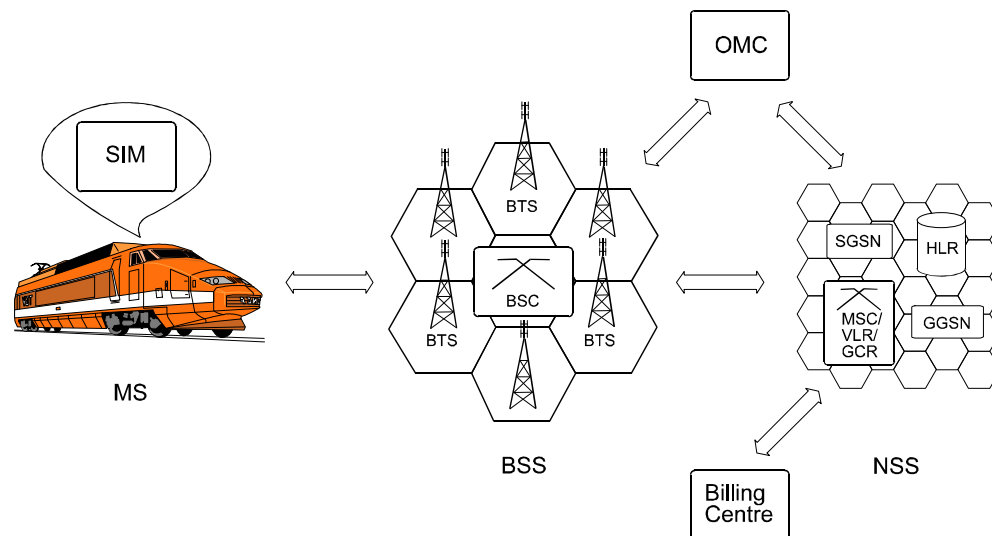

Figure 1-3: GSM architecture overview

1.4.2.2 The system comprises the following elements: (I)

- Base station sub-systems (BSSs) of base station controllers (BSCs) controlling base transceiver stations (BTSs) each containing a number of transceivers (TRXs).
- Network sub-systems (NSSs) interfacing to the BSS via the GSM 'A' interface. The NSS contains mobile services switching centres (MSCs) with primary responsibility for call control. The MSC is supported by a visitor location register (VLR) containing temporary details of subscribers active within the MSC area, a group call register (GCR) containing attributes of voice group and broadcast call configurations for the related MSC area and home location registers (HLRs) holding subscriber details on a permanent basis.
- The network also comprises General Packet Radio Service (GPRS) infrastructure elements supporting the respective packet radio services. The serving GPRS support node (SGSN) is a location register function storing subscription information and location information for each subscriber registered in that node. It interfaces to the BSS via the Gb interface and to the MSC/VLR via the Gs interface and to the HLR via the Gr interface. The gateway GPRS support node (GGSN) is a location register function storing subscription information and routing information (needed to tunnel packet data traffic destined for a GPRS MS to the SGSN where the MS is registered) for each subscriber for which the GGSN has at least one PDP context active. It interfaces to the SGSN via the Gn interface, to the HLR via the Gx interface, to external packet data networks via the Gi interface and to other GSM/GPRS networks via the Gp interface.
- Mobile equipment (ME) interfacing to the BSS via the air (Um) interface.
- Subscriber Identity Modules (SIMs) containing information specific to single subscribers. A standardised interface links mobile equipment to SIM cards. A SIM and ME combined are termed a mobile station (MS).
- Operation and Maintenance Centre (OMC) for managing the network.

- Billing Centre.

1.4.2.3 Signalling within the NSS and between NSSs is carried out according to signalling system number 7, SS7, making specific use of the mobile application part (MAP) of that standard. (I)

1.4.2.4 Railway networks may implement a short message service centre to be interfaced to the GSM network in order to support railway specific messaging applications. (I)

1.4.2.5 A railway GSM network is also likely to have external interfaces to: (I)

- private railway fixed networks;
- public operator networks;
- controller equipment;
- specialised railway systems (eg train control systems).

1.4.2.6 EIRENE will provide the radio bearer for ERTMS/ETCS. The EURORADIO layers are responsible for ensuring the overall safety of the transmission link between train-borne and trackside ERTMS/ETCS applications. (I)

1.4.2.7 In addition to a GSM capability, a direct mode capability may be provided for railway mobiles for set-to-set operation. (I)

1.4.2.8 Standardised interface protocols are to be provided to allow applications external to EIRENE to access EIRENE bearer services. (I)

1.4.2.9 Applications may include: (I)

- public address;
- intercom;
- driver safety device;
- train borne recorder.

1.4.3 Railway specific services and facilities

1.4.3.1 To meet the specific railway requirements, a number of additional features are required some of which have been incorporated in the GSM Standard. The main aspects are summarised in the following paragraphs. (I)

1.4.3.2 **Frequency:** Equipment is to be capable of operation in the following frequency bands: (I)

Band	Frequencies (MHz)
Railway GSM (R-GSM)	876-915/921-960

Note: the R-GSM band includes the Public GSM (P-GSM) and Extended GSM (E-GSM) bands.

- 1.4.3.3 **Voice broadcast and group call facilities:** All mobiles are to support these services as defined in the relevant GSM specifications. The services will mainly be used to: (I)
- broadcast messages from controllers to certain groups of trains in a controller area;
 - broadcast messages from trains or shunting team members to controllers or other mobiles in a defined area;
 - conduct group calls between train drivers and controllers over pre-defined areas;
 - conduct group calls between trackside workers, shunting team members, station staff and similar groups, typically over local areas.
- 1.4.3.4 **Enhanced multi-level precedence and pre-emption:** This GSM specification is to be implemented in order to achieve the high performance requirements necessary for emergency group calls. It is also necessary to meet different grades of service requirements for different types of communications traffic on the system (eg safety (eg train control system), operational and administrative communications). (I)
- 1.4.3.5 **Functional numbering:** Many railway staff need to be addressed by functional rather than personal numbers. The functional numbers may change on a regular basis. The principal example is that of train drivers, who need to be addressed by train numbers which change with each journey. To overcome this difficulty a translation facility will be provided to allow calls to functional numbers to be forwarded to the most appropriate personal number at that time. Thus calls made to a train number are forwarded by the network to the appropriate driver or locomotive for that train at that time. (I)
- 1.4.3.6 A follow-me service will be implemented in the EIRENE network using the GSM Unstructured Supplementary Service Data (USSD) facility to allow users to establish and terminate the forwarding of calls from a functional number to their personal number. (I)
- 1.4.3.7 **Location dependent addressing:** Train drivers need to be able to contact controllers and other staff at the push of a single button. As the train moves through different areas, controllers are liable to change. As a consequence it is necessary to provide a means of addressing calls from a train to certain functions based on the location of the train. (I)
- 1.4.3.8 The only source of location information available within the GSM network is the cell that the train is in. However, there are a number of external sources from which more accurate location information may be derived: (I)
- on-train location systems;

- trackside balises;
- information from ground based systems.

1.4.3.9 Within EIRENE, the primary means of determining the location of a train for the purpose of location dependent addressing will be based on the cell dependent routing. This may be supplemented with additional information from external systems to provide a greater degree of accuracy. (I)

1.4.3.10 **Direct mode:** Railway mobiles may support a direct communications mode whereby a mobile can communicate with all other railway mobiles in a local area without the use of GSM infrastructure. Such a mode is required for use where: (I)

- no GSM infrastructure is provided;
- GSM infrastructure equipment has failed.

1.5 Structure of the specification

1.5.1 The specification is divided into the following separate sections: (I)

1. Introduction;
2. Network requirements;
3. Network configuration;
4. Mobile equipment core specification;
5. Cab radio;
6. General purpose radio;
7. Operational radio;
8. Controller equipment specifications;
9. Numbering plan;
10. Subscriber management;
11. Functional numbering and location dependent addressing;
12. Text messaging;
13. Railway emergency calls;
14. Shunting mode;
15. Direct mode;
- A. References.

1.5.2 Section 2 lists the services and facilities which are to be supported by GSM-R networks. Section 3 provides requirements and recommendations concerning the configuration, planning and implementation of networks. (I)

- 1.5.3 Sections 4, 5, 6, and 7 are concerned with mobile equipment. Section 4 provides specifications applicable to all GSM-R mobiles. Sections 5, 6, and 7 detail the additional requirements for Cab radio, General purpose radio, and Operational radio equipment respectively. Note that for the handheld version of the General purpose radio, commercial standards apply. (I)
- 1.5.4 Section 8 covers controller equipment. Section 9 is concerned with a numbering plan for the variety of functional numbers which are required. Section 10 details the handling of other information, such as priority, closed user groups and encryption algorithms, which must be applied consistently in all networks. (I)
- 1.5.5 Section 11 specifies functional and location dependent addressing. Section 12 refers to the possible use of pre-defined text messages (not required for interoperability). (I)
- 1.5.6 Sections 13 to 15 describe the implementation of emergency calls, shunting mode and direct mode. (I)
- 1.5.7 References for all sections are included in appendix A. (I)

PAGE LEFT INTENTIONALLY BLANK

2 Network requirements

2.1 Introduction

2.1.1 The network services necessary to meet the range of UIC requirements are detailed below. These services are to be considered as a minimum set for implementation within each GSM-R standard network. Railways may implement additional network services as desired. (I)

2.2 GSM teleservices

2.2.1 The GSM teleservices [EN 301 515, Index [24]] to be supported are indicated in table 2-1.

Category	Teleservice	Requirement	Notes
1 Speech transmission	11 Telephony	M	
	12 Emergency calls	M	For '112' calls and not necessarily railway operational emergencies.
2 Short message service	21 Short message MT/PP	O	Service may be used for the passage of text messages.
	22 Short message MO/PP	O	
	23 Short message cell broadcast	O	
6 Facsimile transmission	61 Alternate speech and fax group 3	O	
	62 Automatic fax group 3	O	
9 Voice Group service*	91 Voice Group Call Service (VGCS)	M	
	92 Voice Broadcast Service (VBS)	M	

MT/PP - Mobile Terminated/Point-to-Point

MO/PP - Mobile Originated/Point-to-Point

* Voice Group service specifications contain implementation options. The options required for interoperability are as stated in [MORANE ASCI OPTIONS]

Table 2-1: GSM teleservices to be supported

2.3 GSM bearer services

2.3.1 The GSM bearer services [EN 301 515, Index [23]] to be supported are listed in table 2-2.

Bearer service	Requirement	Notes
20. Asynchronous General Bearer Service	O	
21. Asynchronous 300 bps T	O	
21. Asynchronous 300 bps NT	O	
22. Asynchronous 1.2 kbps T	O	
22. Asynchronous 1.2 kbps NT	O	
23. Asynchronous 1200/75 bps T	O	
23. Asynchronous 1200/75 bps NT	O	
24. Asynchronous 2.4 kbps T	M	Eg V.21, V.22, V.22 bis, V.23, V.32 access Connection to standard ISDN fixed networks
24. Asynchronous 2.4 kbps NT	O	
25. Asynchronous 4.8 kbps T	M	
25. Asynchronous 4.8 kbps NT	O	
26. Asynchronous 9.6 kbps T	M	
26. Asynchronous 9.6 kbps NT	O	
30. Synchronous General Bearer Service	O	
31. Synchronous 1.2 kbps T	O	
31. Synchronous 1.2 kbps NT	O	
32. Synchronous 2.4 kbps T	O	
32. Synchronous 2.4 kbps NT	O	
33. Synchronous 4.8 kbps T	O	
33. Synchronous 4.8 kbps NT	O	
34. Synchronous 9.6 kbps T	O	
34. Synchronous 9.6 kbps NT	O	
40. General PAD Access Bearer Service	O	
41. PAD access 300 bps T	O	
41. PAD access 300 bps NT	O	
42. PAD access 1.2 kbps T	O	
42. PAD access 1.2 kbps NT	O	
43. PAD access 1200/75 bps T	O	
43. PAD access 1200/75 bps NT	O	
44. PAD access 2.4 kbps T	O	
44. PAD access 2.4 kbps NT	O	
45. PAD access 4.8 kbps T	O	
45. PAD access 4.8 kbps NT	O	
46. PAD access 9.6 kbps T	O	
46. PAD access 9.6 kbps NT	O	
61. Alternate speech/data	O	
70. GPRS	O	
81. Speech followed by data	O	

T - Transparent; NT - Non-transparent

Table 2-2: GSM bearer services to be supported

2.3.2 Note: The Adaptive Multi-Rate (AMR) CODEC is not suitable for voice group calls or for voice broadcast calls. (I)

2.4 GSM supplementary services

2.4.1 The GSM supplementary services [EN 301 515, Index [9]] to be supported are listed in table 2-3. The applicability of these supplementary services to GSM basic services will be as indicated in [GSM 02.81-02.89 and EN 301 515, Index [28]]. (I)

Supplementary service	Requirement	Notes
Calling Line Identification Presentation (CLIP)	M	Note 1
Calling Line Identification Restriction (CLIR)	O	
Connected Line Identification Presentation (CoLP)	M	Note 1
Connected Line Identification Restriction (CoLR)	O	
Call Forwarding Unconditional (CFU)	M	Note 2
Call Forwarding on Mobile Subscriber Busy (CFB)	M	Note 3
Call Forwarding on No Reply (CFNRy)	O	
Call forwarding on Mobile Subscriber Not Reachable (CFNRc)	O	
Call waiting (CW)	M	
Call hold (HOLD)	M	
Multi Party Service (MPTY)	M	
Closed User Group (CUG)	M	
Advice of Charge (Information) (AoCI)	O	
Advice of Charge (Charging) (AoCC)	O	
Barring of All Outgoing Calls (BAOC)	O	
Barring of Outgoing International Calls (BOIC)	O	
BOIC except those to Home PLMN Country (BOIC-exHC)	M	
Barring of All Incoming Calls (BAIC)	O	
Barring of Incoming Calls when Roaming Outside the Home PLMN Country (BIC-Roam)	M	
Unstructured Supplementary Service Data (USSD)	M	
Sub-addressing*	M	
Enhanced Multi-Level Precedence and Pre-emption (eMLPP)	M	
Explicit Call Transfer (ECT)	O	
Completion of Calls to Busy Subscribers (CCBS)	O	Note 4
User-to-User Signalling 1 (UUS1)	M	Notes 4 and 5

Note 1 - Provide additional safety check for driver-controller communications

Note 2 - Can be used for train number conversion (see section 11)

Note 3 - To be used for call forwarding where there are multiple radios in the cab

Note 4 - When available - Specification underway

Note 5 - Used for the transfer of functional numbers (sender and receiver) and railway emergency call confirmation messages

* Sub-addressing is not a GSM supplementary service but for convenience is listed in the above table

Table 2-3: GSM supplementary services to be supported

2.5 Railway specific services

2.5.1 The railway specific services to be supported are listed in table 2-4.

Railway service	Requirement	Notes
Functional addressing (section 11)	M	
Location dependent addressing (section 11)	M	
Shunting mode (section 14)	M	
Multiple driver communications (section 5)	M	
Emergency calls (section 13)	M	

Table 2-4: Railway specific services to be supported

2.6 Alerting duration

2.6.1 The call waiting service (CW) permits a party A to be notified of an incoming call from party C whilst the traffic channel is not available for the incoming call and party A is engaged in an active call with party B. However call waiting does not operate during the prior set up of the call between the parties A and B (including alerting if used). Therefore the alerting duration has to be as short as possible in order to minimize the risk for the party A of missing notification of an incoming call from party C with a higher eMLPP priority. Taking into account technical and operational aspects, it is recommended to set the relevant timer(s) in the network in such a way that the maximum alerting duration is limited to 60s. (I)

3 Network configuration

3.1 Introduction

- 3.1.1 EIRENE mobiles are specified to conform to a common minimum standard of performance. It is the responsibility of national railways to design their EIRENE networks to provide the required level of service to EIRENE compliant mobiles. (I)
- 3.1.2 This section draws together specifications and information related to the planning of an EIRENE network and provides guidance on target performance levels. Additional information on communication requirements for the ERTMS/ETCS application is provided in [ERTMS COMMS]. (I)

3.2 Coverage

- 3.2.1 For network planning, the coverage level is defined as the field strength at the antenna on the roof of a train (nominally a height of 4m above the track). An isotropic antenna with a gain of 0dBi is assumed. This criterion will be met with a certain probability in the coverage area. (The target coverage power level is dependent on the statistical fluctuations caused by the actual propagation conditions.) (I)
- 3.2.2 The following minimum values shall apply: (M)
- coverage probability of 95% based on a coverage level of 38.5 dB μ V/m (-98 dBm) for voice and non-safety critical data;
 - coverage probability of 95% based on a coverage level of 41.5 dB μ V/m (-95 dBm) on lines with ETCS levels 2/3 for speeds lower than or equal to 220km/h.
- 3.2.3 The following minimum values are recommended: (I)
- coverage probability of 95% based on a coverage level of 44.5 dB μ V/m (-92 dBm) on lines with ETCS levels 2/3 for speeds above 280km/h;
 - coverage probability of 95% based on a coverage level between 41.5 dB μ V/m and 44.5 dB μ V/m (-95 dBm and -92 dBm) on lines with ETCS levels 2/3 for speeds above 220km/h and lower than or equal to 280km/h.
- 3.2.4 The EIRENE mobile installation shall be designed to operate in a network meeting the criteria in 3.2.2 and 3.2.3. (M)
- Note 1: The specified coverage probability means that with a probability value of at least 95% in each location interval (length: 100m) the measured coverage level shall be greater than or equal to the figures stated above. The coverage levels specified above consider a maximum loss of 3 dB between antenna and receiver and an additional margin of 3 dB for other factors such as ageing. (I).
- Note 2: The values for ETCS levels 2/3 concerning coverage and speed-limitations are to be validated and, if necessary, reviewed after the first operational implementation of ETCS. (I)

3.3 Handover and cell selection

- 3.3.1 The handover success rate should be at least 99.5% over train routes under design load conditions (as given in [EN 301 515, Index [30]]). (O)
- 3.3.2 To avoid the necessity for large cell overlaps to accommodate high speed train operations, optimisation of the handover process for such trains is considered necessary. Suitable algorithms will be tested and refined as necessary during the trials process. (I)
- 3.3.3 The proposed events for measurement of the start and stop of the handover execution at the mobile are: (I)
- receipt of 'handover command';
 - receipt of 'UA' after 'physical info' on new channel.
- 3.3.4 There is a quality of service requirement for handover executions (eg a break of 10s would clearly be unacceptable to the user). 300ms represents our current best estimate of the QoS figure, although this will need to be confirmed through user trials. (I)
- 3.3.5 An additional option is available to reduce the handover break period, namely the use of the synchronous handover capability to reduce the break period to about 150ms. Synchronous handover requires the BTS transmissions in different cells to be synchronised by the system. Each authority can decide whether it wishes to use synchronised BTSs. (I)

3.4 Call setup time requirement

- 3.4.1 Call setup time requirement is dependent upon the eMLPP priority of a call [EN 301 515, Index [27]]. The required priority level for each call type is given in section 10.2. (I)
- 3.4.2 Call setup times as defined in the EIRENE FRS shall be achieved with authentication and ciphering procedures enabled. (M)
- Note: Authentication may be delayed if necessary to achieve the required call setup times.
- 3.4.3 In order to achieve these times the passage of the call through any networks external to GSM (eg from the GSM MSC to a controller linked by an ISDN connection) must take less than 250ms. (I)
- 3.4.4 Achievement of fast call setup times requires information in the setup message to be compressed. A maximum of 12 digits may be sent as mobile originator-to-dispatcher information. (I)

3.5 Frequency band and channel arrangements

- 3.5.1 The network shall operate in a sub-band, or combination of sub-bands, of the R-GSM band as defined in [EN 301 515, Index [35]]. (M)
- 3.5.2 The UIC frequency band for GSM-R is defined in [CEPT 25-09], [1999/569/EC] and [ECC(02)05]: (I)
- 876 – 880 MHz (mobile station transmit); paired with
 - 921 – 925 MHz (base station transmit).
- 3.5.3 The carrier frequency is designated by the absolute radio frequency channel number (ARFCN), and is defined in [EN 301 515, Index [35]]. For carriers in the UIC frequency band the following convention shall be used, where $F_l(n)$ is the frequency value of the carrier ARFCN n in the lower band, and $F_u(n)$ the corresponding frequency value in the upper band: (M)
- $F_l(n) = 890 + 0.2 \cdot (n - 1024)$ $955 \leq n \leq 973$
 - $F_u(n) = F_l(n) + 45$

Frequencies are in MHz.

3.6 DTMF tones and signals

- 3.6.1 The minimum duration of a DTMF tone and the length of pause between tones generated by the network (DTMF sender) and needed for the DTMF digit recognition in the network (DTMF receiver) are specified in [3G TS 23.014, Support of Dual Tone Multi Frequency (DTMF) signalling]. (I)

3.7 Termination of VGCS/VBS calls

- 3.7.1 An entitled controller may terminate a VGCS/VBS call based on DTMF signalling [EN 301 515, Index [4] & [5]]. (I)
- 3.7.2 The network shall terminate the ongoing VGCS/VBS call if it receives the 3-digit sequence “***” transmitted via DTMF signals. (M)
- 3.7.3 In order to minimise the discomfort caused by the DTMF tone added in the voice channel, the duration of the tone generated by the fixed line dispatcher shall be $70\text{ms} \pm 5\text{ms}$, and there shall be a minimum gap of 65ms between each tone. (M)

3.8 Muting and unmuting for VGCS calls

- 3.8.1 The muting and unmuting for VGCS shall be in line with [EN 301 515, Index [4]]. (M)

- 3.8.2 The network shall send the SET-PARAMETER message with the attribute "D-ATT = T"¹ [EN 301 515, Index [6]] to the mobile station of the talking subscriber if it receives the 3-digit sequence "###" transmitted via DTMF or the group call SETUP message² from a controller terminal. However, receiving the 3-digit sequence "###" or the group call SETUP message related to an additional controller while any other controller is talking shall not result in sending another SET-PARAMETER message with the attribute "D-ATT = T". (M)
- 3.8.3 When the network has detected the 3-digit DTMF sequence "###" transmitted via DTMF from a controller terminal and if the controller was not previously talking it should indicate its recognition by playing a single DTMF grant tone "#" of duration of 100ms ± 5ms to be sent to that controller terminal only. (O)
- 3.8.4 The network shall send the SET-PARAMETER message with the attribute "D-ATT = F"³ [EN 301 515, Index [6]] to the mobile of the talking subscriber only if it has received the 3-digit sequence "#**" transmitted via DTMF from all the talking controllers⁴. (M)
- 3.8.5 The duration of each tone (see 3.8.2 and 3.8.4) added in the voice channel, shall be 70ms ± 5ms, and there shall be a minimum gap of 65ms between each tone. (M)

1 On receiving this message, the mobile of the current talking subscriber will stop muting the down-link, thus allowing the subscriber to hear the controller's voice.

2 In the case of a controller as a group call originator, joiner and re-joiner speaking for the first time.

3 On receiving this message, the mobile of the current talking subscriber will resume muting the down-link, thus preventing the subscriber from hearing their own echo.

4 This indicates that all of the controllers have indicated that they no longer wish to speak (for example, by releasing their PTT buttons).

4 Mobile equipment core specification

4.1 Introduction

4.1.1 To ensure interoperability, all EIRENE mobiles are specified with a common level of basic services, facilities and features. This section of the specification gives details of these core requirements, while sections 5-7 detail requirements specific to each of the radio types. (I)

4.1.2 The logical architecture of an EIRENE mobile station (EIRENE MS) is shown in figure 4-1. The architecture consists of the following elements: (I)

- a) **GSM Mobile Termination (GSM-MT):** comprising GSM mobile equipment and SIM;
- b) **Direct Mode Mobile Termination (DM-MT):** for direct mode communications;
- c) **EIRENE applications:** standardised features outside GSM: dependent on radio type;
- d) **Man Machine Interface (MMI):** dependent on radio type.

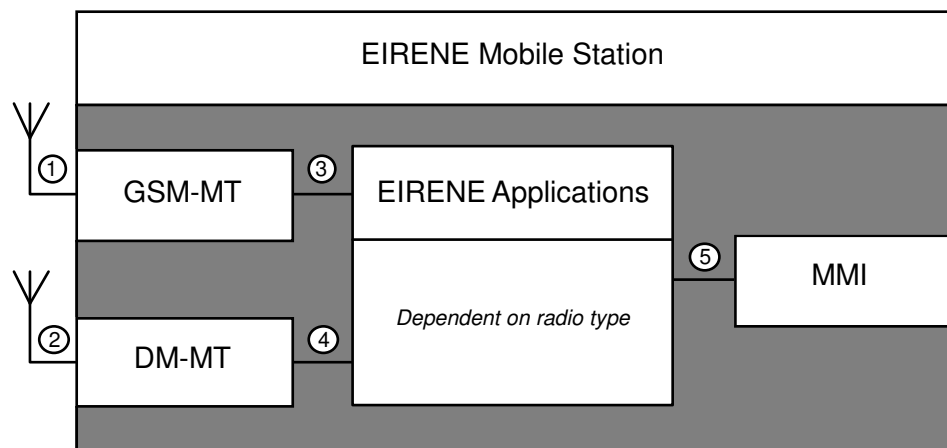

Figure 4-1: Logical mobile radio architecture and interfaces

4.1.3 The logical architecture comprises a number of interfaces between the different EIRENE-MS elements. These are:

- 1) **GSM-MT air interface:** mandatory for interoperability and conformant to GSM specifications; (M)
- 2) **DM-MT air interface:** Direct Mode is optional. However, where implemented, the requirements concerning this interface are mandatory for interoperability; (O)
- 3) **GSM-MT - EIRENE Applications interface:** specified to allow an option for separate procurement of GSM-MT and EIRENE Application equipment for the Cab radio (see [MORANE FFFIS MTI]); (O)

- 4) **DM-MT - EIRENE Applications interface:** specified to allow an option for separate procurement of DM-MT and EIRENE Application equipment for the Cab radio; (O)
- 5) **EIRENE Applications - MMI interface:** not specified. (O)

4.1.4 This specification defines three distinct mobile radio types according to the type of role they will perform and the environment they will operate in, as follows: (I)

- a) Cab radio - for use by the driver of a train and by ERTMS/ETCS;
- b) General purpose radio - for general use by railway personnel;
- c) Operational radio - for use by railway personnel involved in train operations such as shunting and trackside maintenance.

Note: It is possible that the General purpose and Operational radios may have a number of physical implementations to meet railway requirements (eg handheld and vehicle mounted).

4.1.5 All SIM cards used in EIRENE mobiles shall comply with the requirements of the MORANE FFFIS for GSM-R SIM Cards [MORANE SIM]. (M)

4.2 Radio interface aspects

4.2.1 All mobiles shall be capable of operation in the following frequency bands: (M)

Band	Frequencies (MHz)
Railway GSM (R-GSM)	876-915/921-960

Table 4-1: Frequency bands

Note: the R-GSM band includes the Public GSM (P-GSM) and Extended GSM (E-GSM) bands.

4.2.2 The mobile radio antenna installation on vehicles shall be designed so as to ensure that mobiles operate correctly in networks which conform to the design criteria defined in section 3. (M)

4.2.3 Mobile radios shall be of the following power classes: (M)

Radio type	Power class	Power (W)
Cab radio	2	8
General purpose radio	4*	2*
Operational radio	4*	2*

* Vehicle-based versions of the General purpose and Operational radios may be used to provide 8W mobile radios.

Table 4-2: Definition of power classes for each radio type

4.3 Services and facilities

4.3.1 The following GSM teleservices, identified in section 2, are to be supported for each type of mobile radio:

Category	Teleservice	Cab radio	General purpose radio	Operational radio
1 Speech transmission	11 Telephony	M	M	M
	12 Emergency calls	M	M	M
2 Short message service	21 Short message MT/PP	M	M	M
	22 Short message MO/PP	M	M	M
	23 Short message cell broadcast	M	M	M
6 Facsimile transmission	61 Alternate speech and fax group 3	O	O	O
	62 Automatic fax group 3	O	O	O
9 Voice Group service*	91 Voice Group Call Service (VGCS)	M	M	M
	92 Voice Broadcast Service (VBS)	M	M	M

MT/PP - Mobile Terminated/Point-to-Point

MO/PP - Mobile Originated/Point-to-Point

* Voice Group service specifications contain implementation options. The options required for interoperability are as stated in [MORANE ASCI OPTIONS]

Table 4-3: GSM teleservices to be supported

4.3.2 The following bearer services, identified in section 2, are to be supported for each type of mobile radio:

Bearer service	Cab radio	General purpose radio	Operational radio
20. Asynchronous General Bearer Service	O	O	O
21. Asynchronous 300 bps T	O	O	O
21. Asynchronous 300 bps NT	O	O	O
22. Asynchronous 1.2 kbps T	O	O	O
22. Asynchronous 1.2 kbps NT	O	O	O
23. Asynchronous 1200/75 bps T	O	O	O
23. Asynchronous 1200/75 bps NT	O	O	O
24. Asynchronous 2.4 kbps T	M	O	O
24. Asynchronous 2.4 kbps NT	M	O	O
25. Asynchronous 4.8 kbps T	M	O	O
25. Asynchronous 4.8 kbps NT	M	O	O
26. Asynchronous 9.6 kbps T	M	O	O
26. Asynchronous 9.6 kbps NT	M	O	O
30. Synchronous General Bearer Service	O	O	O
31. Synchronous 1.2 kbps T	O	O	O
31. Synchronous 1.2 kbps NT	O	O	O
32. Synchronous 2.4 kbps T	O	O	O
32. Synchronous 2.4 kbps NT	O	O	O
33. Synchronous 4.8 kbps T	O	O	O
33. Synchronous 4.8 kbps NT	O	O	O
34. Synchronous 9.6 kbps T	O	O	O
34. Synchronous 9.6 kbps NT	O	O	O
40. General PAD Access Bearer Service	O	O	O
41. PAD access 300 bps T	O	O	O
41. PAD access 300 bps NT	O	O	O
42. PAD access 1.2 kbps T	O	O	O
42. PAD access 1.2 kbps NT	O	O	O
43. PAD access 1200/75 bps T	O	O	O
43. PAD access 1200/75 bps NT	O	O	O
44. PAD access 2.4 kbps T	O	O	O
44. PAD access 2.4 kbps NT	O	O	O
45. PAD access 4.8 kbps T	O	O	O
45. PAD access 4.8 kbps NT	O	O	O
46. PAD access 9.6 kbps T	O	O	O
46. PAD access 9.6 kbps NT	O	O	O
61. Alternate speech/data	O	O	O
70. GPRS	O	O	O
81. Speech followed by data	O	O	O

T - Transparent; NT - Non-transparent

Table 4-4: GSM bearer services to be supported

4.3.3 The following supplementary services, identified in section 2, are to be supported for each type of mobile radio:

Supplementary service	Cab radio	General purpose radio	Operational radio
Calling Line Identification Presentation (CLIP)	M	M	M
Calling Line Identification Restriction (CLIR)	O	O	O
Connected Line Identification Presentation (CoLP)	M	M	M
Connected Line Identification Restriction (CoLR)	O	O	O
Call Forwarding Unconditional (CFU)	M	O	O
Call Forwarding on Mobile Subscriber Busy (CFB)	O	O	O
Call Forwarding on No Reply (CFNRy)	O	O	O
Call forwarding on Mobile Subscriber Not Reachable (CFNRc)	O	O	O
Call waiting (CW)	M	M	M
Call hold (HOLD)	M	O	O
Multi Party Service (MPTY)	M	O	O
Closed User Group (CUG)	M	O	M
Advice of Charge (Information) (AoCI)	O	O	O
Advice of Charge (Charging) (AoCC)	O	O	O
Barring of All Outgoing Calls (BAOC)	O	O	O
Barring of Outgoing International Calls (BOIC)	O	O	O
BOIC except those to Home PLMN Country (BOIC-exHC)	M	O	M
Barring of All Incoming Calls (BAIC)	O	O	O
Barring of Incoming Calls when Roaming Outside the Home PLMN Country (BIC-Roam)	M	O	M
Unstructured Supplementary Service Data (USSD)	M	M	M
Sub-addressing*	M	O	O
Enhanced Multi-Level Precedence and Pre-emption (eMLPP)	M	M	M
Explicit Call Transfer (ECT)	O	O	O
Completion of Calls to Busy Subscribers (CCBS)	O	O	O
User-to-User Signalling 1 (UUS1)	M	M	M

* Sub-addressing is not a GSM supplementary service but for convenience is listed in the above table

Table 4-5: GSM supplementary services to be supported

4.3.4 The following EIRENE features are to be supported for each type of mobile radio:

	Cab radio	General purpose radio	Operational radio
Functional addressing (section 11)	M	M	M
Direct mode (section 15)	O	N/A	O
Shunting mode (section 14)	M	N/A	O
Multiple driver communications (section 5)	M	N/A	N/A
Railway emergency calls (section 13)	M	O	M

Table 4-6: EIRENE features to be supported

4.3.5 If a Railway emergency call set up from an EIRENE radio is unsuccessful, the radio shall automatically re-attempt the call setup until the call setup is successful, a retry timer expires (duration 30 seconds, as specified in the [EIRENE FRS]) or the user abandons the call. (M)

Note: For this, the higher layers of an EIRENE radio shall automatically repeat setup requests to the layer 3 GCC or BCC entity as soon as an indication is given from the layer 3 GCC or BCC entity on an abort of the establishment procedure without the service being explicitly rejected by the network. No change of the related layer 3 procedures of GSM is intended. (M)

4.4 Core MMI requirements

4.4.1 A service availability indication shall be provided to radio users, as defined in [EN 301 515, Index [26]]. (M)

4.4.2 The user shall be prevented from entering direct mode if the GSM service is available. (M)

4.4.3 If the attempt to establish a Railway emergency call is not successful after 2 seconds, an indication shall be provided to the user of the status of the establishment request procedure. (M)

4.5 Core environmental requirements

4.5.1 This subsection defines the core environmental and physical requirements for all EIRENE mobile equipment. The requirements provided in this section are augmented by those provided in later sections for each individual radio type, with each radio type being specified by the superset of the core plus specific requirements. (I)

4.5.2 All EIRENE mobile equipment shall comply with all environmental, EMC and physical specifications defined in the GSM standard, especially with reference to [GSM 05.90 and EN 301 515, Index [2] & [35]]. (M)

4.5.3 All EIRENE mobile equipment shall conform to [EN 60950] (Safety of Information Technology Equipment), including Electrical Business Equipment, 1993, plus amendments A1 and A2. (M)

4.5.4 The categories of requirements defined in each section describing mobile equipment are as follows: (I)

- climatic conditions (temperature, humidity, solar radiation, altitude, etc);
- physical conditions (flammability, contamination, physical protection, etc);
- mechanical conditions (shock and vibration);
- electrical conditions (power supply variation, battery life, overloading, etc);
- EMC (both emissions and immunity);
- tests required to validate compliance with EIRENE specification.

4.5.5 Any environmental and physical requirements stated may be superseded by national requirements provided the national standards provide a higher level of environmental and physical protection. Stricter national standards shall not prevent the use of other EIRENE mobiles in that country. (M)

4.5.6 Many of the railway specific standards referenced are Pre-standards (eg [prEN 50155, ENV 50121, prEN 50125]) and should be re-examined for their applicability to the EIRENE system if any modifications are made to these standards in the future. (I)

4.5.7 All design, manufacturing, testing and installation of EIRENE mobile radio equipment shall comply with the quality procedures defined in [ISO 9001]. (M)

Climatic conditions

4.5.8 EIRENE mobile equipment shall be capable of operating over a standard range of temperatures from -20°C to +55°C. (M)

4.5.9 EIRENE mobile equipment shall be capable of being stored (ie without being operational) at temperatures down to -40°C without any permanent damage. (M)

- 4.5.10 The equipment shall be capable of coping with temperature variations of up to +/- 1°C/minute. (M)
- 4.5.11 EIRENE mobile equipment shall be capable of operating between altitudes of -100m and 1800m, referenced to sea level. (M)
- 4.5.12 The equipment shall be able to cope with relative humidities of 100% for short periods, although the yearly average is expected to be 75%. The equipment shall also cope with 95% humidity for 30 days in the year. (M)
- 4.5.13 Operationally caused infrequent and slight moisture condensation shall not lead to any malfunction or failure. (M)
- 4.5.14 All equipment shall not degrade photochemically when exposed to solar radiation of up to 1200 W/m². (M)
- 4.5.15 In normal operation of a mobile radio unit, it shall be expected that a combination of the above environmental conditions will be experienced. (M)

Mechanical conditions

- 4.5.16 All EIRENE mobile equipment shall be protected against shock and vibration in compliance with standards defined in [prEN 50125] using tests defined in [prEN 50155]. (M)
- 4.5.17 All handheld mobile equipment shall be capable of withstanding the following shocks: (M)
- non-repetitive shocks of up to 3g for up to 100ms under normal conditions;
 - free fall from 0.5m.
- 4.5.18 EIRENE mobile equipment shall be capable of being subjected to both sinusoidal and random vibration. (M)
- 4.5.19 Handheld mobile equipment shall be capable of withstanding the following levels of continuous sinusoidal vibration: (M)
- frequency range: 5-200 Hz;
 - peak-to-peak amplitude: 7.5 mm;
 - peak acceleration: 1.5g.
- 4.5.20 The random vibrations to be withstood by mobile equipment shall be 0.25g in all three axes of freedom. (M)

Electrical

- 4.5.21 For determining battery requirements, the transmit/receive duty cycles used shall be as shown in table 4-7 for each call type. (M)

Call type	Transmit	Receive
Point-to-point call	100%	100%
Group call	30%	100%
Broadcast call (originated)	100%	100%*
Broadcast call (receive)	0%	100%

* Because it is necessary to receive a broadcast call while transmitting, the speaker's link to the network is via a standard point-to-point call

Table 4-7: Transmit/receive duty cycles for different call types

4.5.22 Battery requirements shall be provided without the use of discontinuous reception or transmission (DTX/DRX). (M)

4.5.23 Battery requirements shall be met based on full power during transmission and assuming hourly periodic location updating. (M)

Electromagnetic Compatibility

4.5.24 All railway and generic EMC standards define a maximum level of radiated EMC for a range of frequencies. However, the nature of radio equipment implies a certain level of EM emission in the transmission band. (I)

4.5.25 Guidelines concerning the effects of GSM emissions on hearing aids, pace makers and other sensitive electrical equipment are provided in [GSM 05.90]. (I)

4.5.26 All EIRENE mobile equipment shall be immune to external EMC as defined in [ENV 50121 part 4]. (M)

NOTE: EIRENE mobile equipment cannot comply with the emission requirements defined in this standard except outside the GSM transmission band.

4.5.27 The transmission of EM radiation from all EIRENE mobile equipment shall comply with the radio frequency transmission masks defined in [EN 301 515, Index [35]] for the range of GSM frequencies defined in section 1 of this document. (M)

4.5.28 Where the emission levels defined by [EN 301 515, Index [35]] exceed those stated in [ENV 50121 part 4], the GSM specification shall take precedence. (M)

4.5.29 Mobile equipment shall comply with the generic standard for EMC in the industrial environment as defined in [ENV 50081 part 2], except for emissions at GSM frequencies as noted above. (M)

- 4.5.30 The emission and immunity standards for the general railway environment and ancillary services as defined in [ENV 50121 parts 1, 2, 3-1, 3-2 and 5] shall be considered. (M)
- 4.5.31 EIRENE mobiles will generate EM emissions in the GSM frequency band. It is the responsibility of national railways operating EIRENE networks to ensure that EIRENE equipment does not interfere with the normal operation of any on-train or ground based systems. (I)
- 4.5.32 In particular, EIRENE equipment could interfere with: (I)
- signalling relays and contacts;
 - speedometers;
 - public address;
 - power transformers;
 - track circuits;
 - axle counters;
 - train describers;
 - other radio equipment;
 - radar speed measurement equipment;
 - switched mode power supplies;
 - telecommunications circuits;
 - electronic locking systems.

Testing procedures

- 4.5.33 The environmental and physical tolerance of the EIRENE mobile radio units shall be tested at a facility in accordance with [EN 45001]. (M)
- 4.5.34 All EMC emission and immunity tests shall be performed in accordance with guidelines defined in the [EN 61000-4] series and in [EN 50140]. (M)
- 4.5.35 Environmental testing procedures shall follow guidelines defined in [IEC 68 part 1]. (M)
- 4.5.36 Specific environmental test procedures to be followed for EIRENE mobile equipment shall include the following tests as defined in the [IEC 68] series: (M)
- A Cold;
 - B Dry heat;
 - D Damp heat (cyclic);
 - E Impact;
 - F Vibration;
 - G Acceleration;
 - K Corrosive atmospheres;
 - M Air pressure;
 - N Change of temperature;
 - P Fire hazard.

PAGE LEFT INTENTIONALLY BLANK

5 Cab radio

5.1 Introduction

5.1.1 This section identifies the system requirements for the EIRENE Cab radio. It defines how the functionality is to be provided by the Cab radio system and the man-machine interface. (I)

5.2 System components

5.2.1 Figure 5-1 shows the logical architecture of an EIRENE Cab radio. The architecture comprises the following elements: (I)

- **GSM Mobile Termination (GSM-MT):** comprising GSM mobile equipment and SIM;
- **Direct Mode Mobile Termination (DM-MT):** for direct mode communications;
- **EIRENE Cab radio applications:** standardised features outside GSM;
- **Man Machine Interface (MMI).**

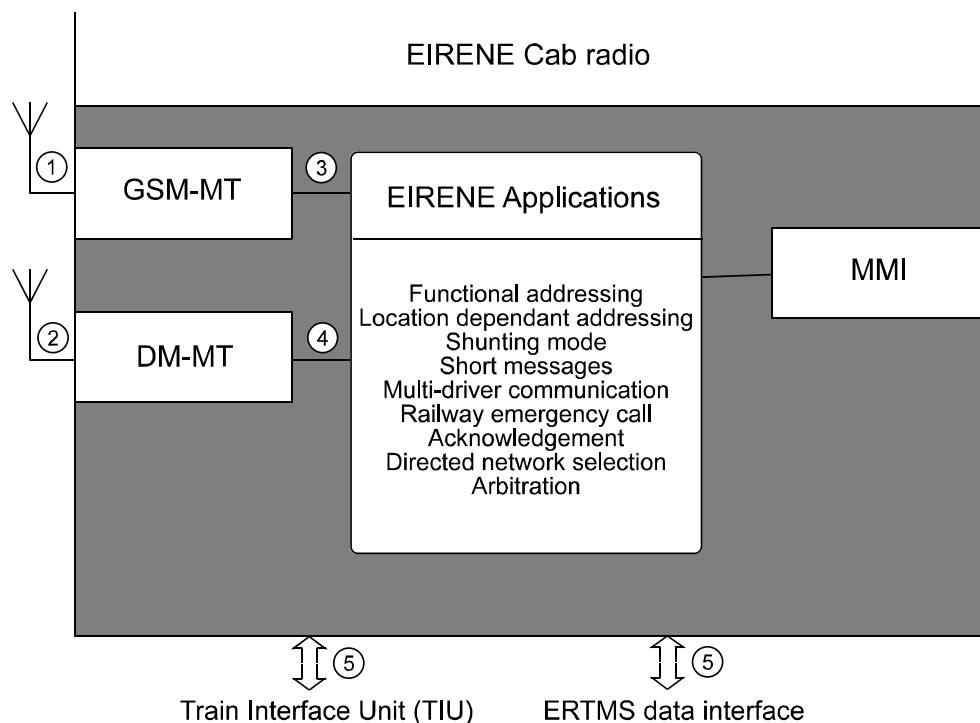

Figure 5-1: Logical Cab radio architecture and interfaces

5.2.2 The architecture comprises a number of interfaces between the different EIRENE-MS elements. These are:

- 1) **GSM-MT air interface:** mandatory for interoperability and conformant to GSM specifications. (M)

- 2) **DM-MT air interface:** Direct Mode is optional. However, where implemented, the requirements concerning this interface are mandatory for interoperability. (O)
- 3) **GSM-MT - EIRENE Applications interface:** specified to allow the option for separate procurement of GSM-MT and EIRENE Application equipment for the Cab radio. The Morane FFFIS [MORANE FFFIS MTI] specifies two types of interface based on V.24 and TDMA, both supporting [EN 301 515, Index [19]]. (O)
 [Note: this interface is not required where a Cab radio is implemented as an integrated unit.]
- 4) **DM-MT - EIRENE Applications interface:** specified to allow the option for separate procurement of DM-MT and EIRENE Application equipment for Cab radio. (O)
- 5) Interfaces may be provided to a Train Interface Unit and an ERTMS data interface. More requirements are given on these interfaces, where implemented, in subsections 5.10 and 5.15. (I)

5.3 Driver call-related functions

Call controller

- 5.3.1 Upon an appropriate MMI action, the radio shall initiate a call to the appropriate controller with 'Railway operation' priority (see section 10.2). (M)
- 5.3.2 The calling driver's functional number shall be passed to the network using UUS1. (M)

Call other drivers in the area

- 5.3.3 On receipt of a 'Call other drivers in area' request, the radio shall initiate a group call using the 'all trains' group identification (see section 9) with eMLPP priority level 2 (see section 10.2). (M)
- 5.3.4 The calling driver's functional number shall be passed to the network using UUS1. (M)

Send Railway emergency call

- 5.3.5 Activation of the 'Railway emergency call' function shall cause the radio to initiate a Railway emergency call as defined in section 13. (M)
- 5.3.6 The calling driver's functional number shall be passed to the network using UUS1. (M)

Communicate with other drivers on same train

- 5.3.7 Many trains employ multiple active traction vehicles. Where these vehicles are not connected by on-train wiring, it shall be possible for a permanent radio connection to be established between each of the active cabs. (I)

- 5.3.8 Where there is more than one active cab, the radio connection shall be provided using the GSM Multi-Party service. (M)
- 5.3.9 The call will be established from the active cab of the lead traction vehicle. Each of the other cabs on the train will be contacted using its functional number (registered by the other drivers prior to the establishment of the call). The procedure for setting up a multi-party call is outlined in figure 5-2. The multi-party call shall have 'Railway operation' priority (see section 10.2) and whilst on-going a 'multi-drivers' indication shall be displayed permanently at all Cab radios. (M)

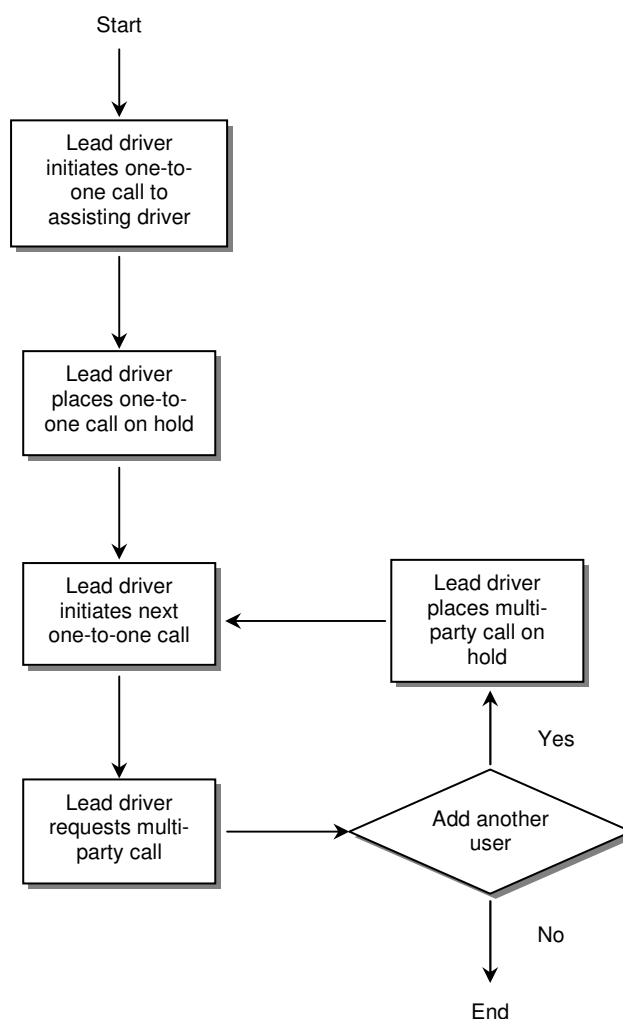

Figure 5-2: Multi-party call initiation

Call train staff

- 5.3.10 Upon activation of the function 'Call train staff', the radio shall determine the appropriate functional number based on the staff member selected and the train number (see section 9). A GSM point-to-point voice call at 'Railway operation' priority (see section 10.2) shall then be initiated. (M)

Call other authorised users

- 5.3.11 The Cab radio shall be capable of being used as a standard GSM telephone, such that the driver is able to call any valid number subject to closed user group, call barring or other restrictions. (M)

Receive short (SMS) text messages

- 5.3.12 The Cab radio shall be able to receive, display and store incoming short (SMS) text messages (see section 12). (M)

Enter/leave shunting mode

- 5.3.13 The Cab radio shall support shunting mode communications as defined in section 14. (M)

Enter/leave direct mode

- 5.3.14 The Cab radio should support direct mode communications as defined in section 15. (O)

5.4 MMI functions

Switch radio on and off

- 5.4.1 When switched on, the radio shall initiate automatic self-testing using the GSM IMSI attach procedure (including the automatic selection of the default loudspeaker volume – see table 5-1). (M)
- 5.4.2 Upon switch on, the Cab radio shall be registered with a mobile network (see section 10.5). (M)
- 5.4.3 If registration is not successful an audible and visual indication shall be provided. (M)
- 5.4.4 Upon registration, the mobile shall be accessible by calling the MSISDN or the Engine or Coach number with which it is associated. This shall require the home network database to maintain this correlation. (M)

Adjust loudspeaker volume

- 5.4.5 The following table provides details of the three volume adjustment ranges to be provided. (O)

Levels of adjustment		Driver adjustment		
		Quiet cab	Normal cab	Noisy cab
250 mW	24 dBm	1	1	
355 mW	25.5 dBm	2		
500 mW	27 dBm	3	2	1
1 W	30 dBm	4	3	2
2 W	33 dBm	5	4	3
4 W	36 dBm		5	4
8.5 W	39 dBm			5

Table 5-1: Volume adjustment levels

- 5.4.6 The numbers 1 to 5 give the five levels of adjustment possible for each volume range setting. The default setting is the pre-defined level automatically selected when the MMI is switched on. (I)

Register and deregister train number

- 5.4.7 Upon activation of the registration function, a USSD message (see section 11) shall be sent by the Cab radio. (M)
- 5.4.8 Upon activation of the deregistration function, a USSD message (see section 11) shall be sent by the Cab radio. (M)
- 5.4.9 Upon detection (automatically or based on a list stored in the Cab radio) of the additional on-train functions for equipment physically connected to the Cab radio, a USSD message (see section 11) shall be sent by the Cab radio after activation of the registration or deregistration function. (M)

Register and deregister stock number

- 5.4.10 This procedure shall take place at the installation of the Cab radio. It shall be initiated by an external device or by a member of a maintenance team. (M)
- 5.4.11 On-train functions for equipment physically connected to the Cab radio shall be registered or deregistered automatically based on a USSD message (see section 11) sent by the Cab radio. (M)

5.5 Handling of calls

- 5.5.1 The sequence of actions required for a mobile originated call to another user shall be as follows: (M)

- Initiating a call: System is provided with the necessary information to set up call (eg number, bearer type, priority);
- Indication: Provide an audible and visual indication;
- Call arbitration: Management of call requests on the basis of call priority;
- Conversation: Where the parties involved in the call can communicate;
- Call termination: Where one of the parties involved in the call terminates the call.

5.5.2 The sequence of actions for a mobile terminated call to a driver shall be as follows: (M)

- Call arbitration: Management of call requests on the basis of call priority;
- Indication: Provide an audible and visual indication of incoming call;
- Answering the call: Acceptance of incoming call by user (not required for auto answer);
- Indication: Provide an audible and visual indication;
- Conversation: Where the parties involved in the call can communicate;
- Call termination: Where one of the parties involved in the call terminates the call.

5.5.3 The Cab radio system shall provide a means for the driver to terminate established calls which he is authorised to terminate. (M)

Initiating a call

5.5.4 It shall be possible to initiate outgoing voice calls in one of four ways depending on the intended recipient(s) of the call: (M)

- Emergency access: Capable of rapid activation in an emergency with a minimum of action being required by the driver (ie single red button);
- Priority access: Requiring the minimum of driver actions to initiate a call (eg a single key stroke);
- Stored number: Through the selection of a stored number or name (eg menu type access);
- Dial access: Facility for the driver to enter or select telephone or functional numbers manually.

Emergency access

5.5.5 Emergency access shall be provided to initiate the following call: (M)

Destination	Call type	eMLPP priority designation	Additional information
Emergency call number	Group call	0	Functional number

Table 5-2: Call types requiring MMI emergency access

Priority access

5.5.6 Priority access shall be provided to initiate the following: (M)

Destination	Call type	eMLPP priority designation	Additional information
Primary controller (*)	Point-to-point	3	Functional number
Secondary controller (*)	Point-to-point	3	Functional number
Power supply controller (*)	Point-to-point	3	Functional number
Other drivers in area	Group call	2	Functional number
Other drivers on same train	Point-to-point (Multi Party)	3	Functional number
Chief conductor	Point-to-point	3	Functional number

(*) For these destinations, see the requirement below.

Table 5-3: Call types requiring MMI priority access

5.5.7 On activation of the “call other drivers on the same train” function, the MMI shall provide additional guidance to the user in the establishment and management of a Multi-Party call. (M)

5.5.8 (*) When there are several controllers of the same type associated with a cell, and no external means of selecting the appropriate one, the choice may be given by the system to the driver, or a VGCS call may be established to all of the relevant controllers after initiating the ‘Call controller’ function. (I)

Stored numbers

5.5.9 The driver shall be able to initiate a call by selecting a name/number from stored number information in the radio. (M)

5.5.10 Facilities shall be provided to support a list of stored names/numbers of up to a minimum of 100 entries. (M)

5.5.11 Stored number access shall be provided to initiate the following calls: (M)

Destination	Call type	eMLPP priority designation	Additional information
Calls to stored numbers	Point-to-point/ VGCS/VBS	4	Functional number

Table 5-4: Call types requiring MMI stored number access

5.5.12 Unless otherwise indicated at time of entry, calls from the stored numbers list shall be initiated as voice calls. (M)

5.5.13 By default, calls will have a priority of railway information calls (eMLPP priority designation 4). It shall be possible to store a priority in association with a stored number. (M)

Dial access

5.5.14 The driver shall be able to initiate a call by dialling any valid telephone number or functional number. (M)

5.5.15 Dial access shall be provided to initiate the following calls: (M)

Destination	Call type	eMLPP priority designation	Additional information
Calls to other users	Point-to-point/ VGCS/VBS	4	Functional number

Table 5-5: Call types requiring MMI dial access

5.5.16 Abbreviated dialling facilities shall be supported. (M)

5.5.17 Dialled calls from the MMI shall be point-to-point voice calls unless otherwise entered from the MMI at the time of initiation. (M)

5.5.18 By default, dialled calls shall have a priority of railway information calls (eMLPP priority designation 4). (M)

Receiving a call

5.5.19 It shall be possible to receive and manage the following incoming calls: (M)

- emergency calls;
- group calls;
- broadcast calls;
- point-to-point calls;

- multi-party calls.

Call arbitration

- 5.5.20 The Cab radio shall arbitrate between calls when:
- an incoming call is received whilst the Cab radio is in an on-going call; (M)
 - a Cab radio user attempts to initiate a call whilst the Cab radio is in an on-going call. (M)
- 5.5.21 The Cab radio shall apply the arbitration rules outlined in Table 5A-1 in Appendix 5A. (M)

Conversation

- 5.5.22 Once a call has been established the connected parties shall be able to communicate. (M)
- 5.5.23 Replacing the handset shall result in the outcomes listed in Tables 5A-2 and 5A-3. (M)

Call termination

- 5.5.24 Calls shall be able to be terminated by either party subject to the requirements shown in tables 5A-2 and 5A-3. (M)

a) Outgoing calls

- 5.5.25 Table 5A-2 in Appendix 5A shows the effect of replacing the handset or initiating the 'Call clear' procedure for the different types of outgoing calls. (M)

b) Incoming calls

- 5.5.26 Table 5A-3 in Appendix 5A shows the effect of putting down the handset or initiating the 'Call clear' procedure for the different types of incoming calls. (M)

5.6 **Other Cab radio functions**

Handle incoming/outgoing calls to/from appropriate on-train users or devices

- 5.6.1 Incoming calls to the Cab radio shall be routed to the correct on-train user or device using information contained in the sub-addressing field. (M)

Manual network selection

- 5.6.1i Using the GSM “Manual” network selection procedure, the Cab radio application shall allow the driver to access a prioritised list of authorised networks (to be displayed as stated in section 10.5) and shall allow the driver to select a desired network from this list. This function shall not be available if there is an ongoing voice call involving the Cab radio. (M)

Directed network selection

- 5.6.2 As a train approaches the limits of the coverage of the PLMN it is registered with, it will be necessary for it to register with the next PLMN providing coverage. (I)
- 5.6.3 A means of directed network selection should be provided to ensure that the MS registers with the required network. (O)
- 5.6.4 If directed network selection is implemented, the directed network selection procedure shall be initiated by an external trigger mechanism, which instructs the Cab radio application to select the required network unless a voice call is ongoing. (M)
- 5.6.4i If directed network selection is implemented and voice calls are ongoing at the time when the external device attempts to trigger a network change, an audible and visual indication shall be given to the driver and network change shall be deferred until the call is terminated or until coverage of the current network is lost. (M)
- 5.6.5 If directed network selection is implemented, the Cab radio application shall use the GSM “Manual” network selection procedure (through the AT interface [EN 301 515, Index [19]]) to instruct the MT to register with the required network. (M)

Automatic network selection

- 5.6.5i The Cab radio should be capable of selecting the most appropriate mobile radio network automatically using the selection criteria stated in section 10.5. (O)
- 5.6.5ii If automatic network selection is implemented, the driver shall be capable of deactivating and/or re-activating this function using simple MMI actions. (M)
- 5.6.5iii Whilst automatic network selection is enabled, the MMI shall display an indication. (M)

Service availability

- 5.6.6 In idle mode, if the GSM Service Indicator (see [EN 301 515, Index [26]]) is lost, the mobile shall give an audible and visual indication. (M)

5.7 Environmental and physical

- 5.7.1 Train-mounted equipment including the Cab radio terminal equipment, MMI and antenna shall comply with all specifications in section 4 and all of those defined in this section, with those defined in this section taking priority. (M)
- 5.7.2 Two types of mobile radio equipment will be mounted in rolling stock: in-cab equipment and external equipment. Each type of equipment has slightly different requirements placed upon it in terms of EMC and climate. ([UIC 651] is a useful reference concerning the layout of cab equipment.) (I)

Climatic conditions

- 5.7.3 The Cab radio shall be capable of operating within a temperature range of -20°C to +70°C. (M)
- 5.7.4 The aerial and any other equipment mounted external to the train shall be capable of withstanding extremes of temperature from -40°C to +70°C. (M)
- 5.7.5 The aerial and any other equipment mounted external to the train shall function correctly during rapid temperature fluctuations of up to 3°C/second. (M)
- 5.7.6 Any equipment mounted external to the train cab shall withstand the following additional physical conditions: (M)
- in-tunnel pressure pulses of 6 kPa (peak to peak) for up to 3 seconds;
 - pressure gradients of up to 100 kPa/s.

Physical conditions

- 5.7.7 Measures should be taken to reduce the risk of theft of radio equipment. Examples of such measures include physical protection, alarms and access control measures. (O)
- 5.7.8 Ease of maintenance should be taken into account in the design and installation of radio equipment. For example, maintenance access to antennas on vehicles should be provided. (O)
- 5.7.9 The “Subscriber Identity Module” (SIM card) shall be physically integrated with the radio set and shall not be able to be removed except by maintenance staff. (M)
- 5.7.10 The Cab radio should be mounted in the train cab in compliance with [prEN 50261]. (O)

Mechanical conditions

- 5.7.11 Any equipment mounted inside the train cab shall be capable of withstanding the following maximum levels of sinusoidal vibration: (M)
- frequency range: 5-200 Hz;

- peak-to-peak amplitude: 7mm;
- acceleration: 1.5g.

5.7.12 Any equipment mounted external to the train cab shall withstand the following maximum levels of sinusoidal vibration: (M)

- frequency range: 5-1000 Hz;
- peak-to-peak amplitude: 5mm;
- acceleration: 2.5g.

Electrical

5.7.13 The Cab radio shall comply with draft European standard [prEN 50124 part 1] concerning insulation co-ordination with reference to clearances and creepages. (M)

5.7.14 An emergency power supply should be provided for Cab radios which will enable the driver's radio to continue to operate for a period of 6 hours in the event of failure of the train's main power supply, based on the following cycle (see section 4.5.21): (O)

- point-to-point calls 20%;
- group calls 5%;
- standby 75%.

5.7.15 The Cab radio equipment shall be capable of withstanding the following changes to the main and backup power supplies without interrupting normal operation: (M)

- voltage fluctuations up to $\pm 15\%$ of nominal supply voltage;
- 20% over voltage for up to 10s;
- other transient effects according to [IEC 571 parts 1-3].

5.7.16 The Cab radio shall withstand the effects of power supply transients as defined in [prEN 50155]. (M)

5.7.17 The driver and other in-cab equipment shall be protected against all electrical hazards arising from EIRENE mobile equipment as defined in [EN 50153]. (M)

Electromagnetic Compatibility

5.7.18 Requirements on EMC emissions for the Cab radio are to be more stringent than those defined for other radio types due to close proximity to other train mounted control and protection equipment, and higher transmission power. (I)

5.7.19 EMC emission from the Cab radio shall comply with [ENV 50121 parts 1, 2, 3-2 and 4]. (M)

5.7.20 Emissions from the train mounted antenna associated with the Cab radio shall be limited to those specified by [EN 301 515, Index [35]]. (M)

- 5.7.21 Any emissions radiating into the driver's cab and other on-board equipment from the exterior aerial shall meet the requirements defined in [ENV 50121 parts 1, 2, 3-1, 3-2 and 4] to the highest possible degree. (M)

Testing procedures

- 5.7.22 The Cab radio shall pass electrical tests as defined in [IEC 571 parts 1, 2 and 3]. (M)
- 5.7.23 Additional guidelines on testing procedures may be taken from [prEN 50129] and [IEC 1508 part 1]. (I)

5.8 Cab radio interfaces to on-train systems

- 5.8.1 The following list catalogues the interfaces that should be provided by the Cab Radio to the on-train systems:
- Train borne recorder; (O)
 - ERTMS/ETCS interface; (O)
 - Public Address; (O)
 - UIC Intercom; (O)
 - Driver's Safety Device; (O)
 - Other interfaces. (O)
- 5.8.2 Where implemented, these interfaces are subject to the requirements stated in the following sections. (I)

5.9 Train borne recorder

- 5.9.1 The Cab radio and the train borne recorder may be connected via the Train Interface Unit (TIU) or may be connected directly by means of a nationally determined interface. (I)

5.10 ERTMS/ETCS interface

- 5.10.1 Some Cab radios will be required to provide communications for ERTMS/ETCS. (I)
- 5.10.2 If ERTMS/ETCS communications are required, an interface as defined in the FFFIS for EURORADIO [MORANE EURO FFFIS] shall be implemented. (M)

5.11 Public Address interface

- 5.11.1 If implemented, the Public Address interface should comply with the specifications of the UIC Fiche [UIC 568]. (O)

5.12 UIC Intercom

- 5.12.1 If implemented, the UIC interface should comply with the specifications of the UIC Fiches [UIC 558, 568]. (O)

5.13 Driver's Safety Device

- 5.13.1 The Cab radio and the Driver's Safety Device may be connected via the Train Interface Unit (TIU) or may be connected directly by means of a nationally determined interface. (I)

5.14 Other interfaces

- 5.14.1 Other interfaces may take the form of additional audio and data inputs and outputs. (I)
- 5.14.2 Where other data interfaces are implemented, they should be of the RS422 standard. (O)

5.15 Train Interface Unit (TIU)

- 5.15.1 Where necessary, a Train Interface Unit may be implemented to adapt on-train systems to the standard interfaces provided by the Cab radio. (I)
- 5.15.2 The interfaces between the TIU and the on-train systems are outside of the scope of EIRENE standardisation. (I)
- 5.15.3 Figure 5-3 shows an example of how the Train Interface Unit may be implemented: (I)

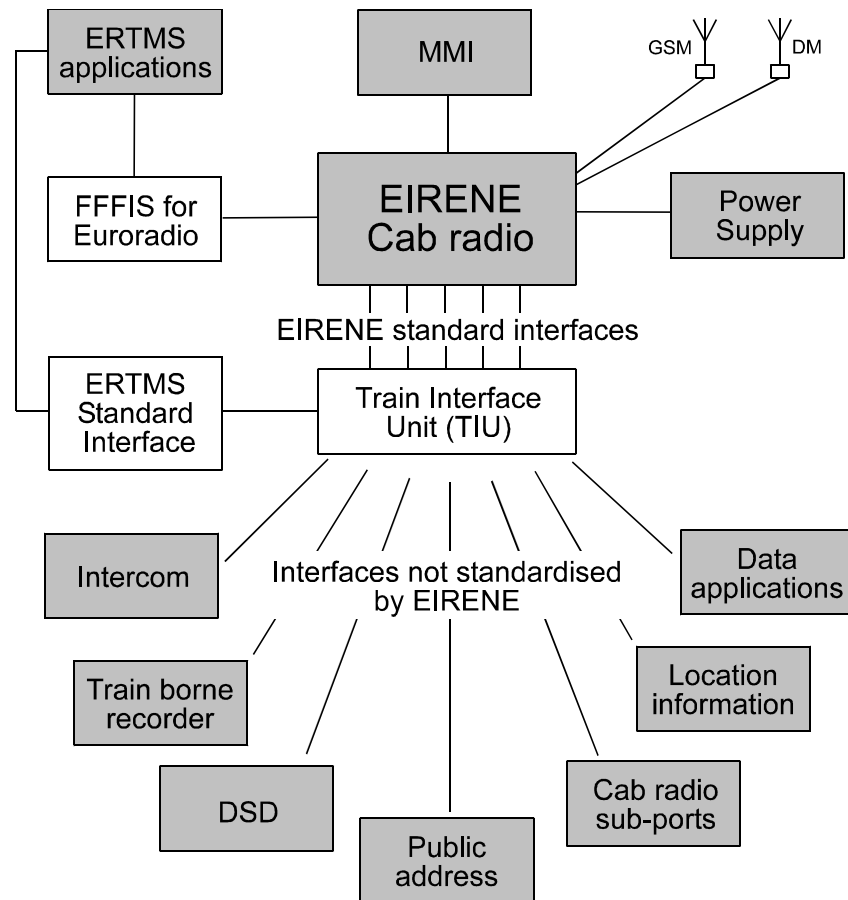

Figure 5-3: Interfaces to the Cab radio

PAGE LEFT INTENTIONALLY BLANK

5A Handling of calls

5A.1 Call arbitration table

On-going call	New call	Result	Comment
Emergency (Railway emergency call)	Emergency (driver initiated)	No change *	(*) At least displayed to the controller
	Intercom (driver initiated)	Intercom connected (2)	
	PA (driver initiated)	PA connected (2)	
	Call chief conductor (driver initiated)	Emergency call maintained, new call sent by UIC Intercom link (3)	
	Other incoming calls (including other emergency calls)	Emergency is kept Incoming call is indicated	
Other drivers same area (group call)	Emergency (driver initiated)	On-going call is released and emergency call established	
	Public Address (driver initiated)	PA connected (2)	
	Call chief conductor (driver initiated)	Call sent by UIC Intercom link (3)	
	Intercom (driver initiated)	Intercom connected (2)	
	Emergency (controller initiated)	Call is released Emergency call connected	
	Other incoming calls	On-going call is maintained and incoming call is clearly indicated.	
Controller (all types)	Emergency (driver initiated)	On-going call is released and emergency call established	
	Public Address (driver initiated)	PA connected Controller is released	
	Call chief conductor (driver initiated)	Call sent by UIC Intercom link (3)	
	Intercom (driver initiated)	Intercom connected Controller is released	
	Other outgoing calls (driver initiated)	New call connected On-going call put on hold	
	Emergency (controller initiated)	On-going call is released and emergency call established	

On-going call	New call	Result	Comment
	Other drivers in same area	On-going call is released and incoming call established	
	Other incoming calls	On-going call is maintained and incoming call is clearly indicated	
Other drivers same train (multiple driver communications by radio link) (7)	Emergency (driver initiated)	On-going call is released and emergency call established	Leading driver may re-establish call to non leading drivers at the end of emergency call
	Public Address (driver initiated)	PA connected (2)	
	Call chief conductor (driver initiated)	Call sent by UIC Intercom link (3)	
	Emergency (controller initiated)	On-going call is released and emergency call established	
	Intercom (driver initiated)	Intercom connected (2)	
	Other outgoing calls (driver initiated)	New call connected Multi-driver communication put on hold	
	Call to controller (driver initiated)	Call connected	Multi-driver communications placed on hold or driver may add controller to multi-driver communication
	Other drivers same area (incoming)	On-going call is released and incoming call established	
	Other incoming calls from controller	On-going call is maintained and the controller is added	
	Other incoming calls	On-going call is maintained and incoming call is clearly indicated	

On-going call	New call	Result	Comment
Public Address (over radio link)	Emergency (driver initiated)	PA call is released and emergency call established	
	Public Address (driver initiated)	No change (6)	
	Call chief conductor (driver initiated)	Call sent (by PA)	
	Intercom (driver initiated)	PA retained Intercom connected	
	Call controller (all types)	PA released Call sent	
	Intercom (controller initiated) Emergency (controller initiated) Other drivers in same area and Controller (all types)	PA released Incoming call received	
	Other calls	PA call is maintained, incoming call is indicated	
PA (not radio link)	Emergency (driver initiated)	PA call is released and emergency call established	
	Call controller (all types)	PA released Call sent	
	Public Address (driver initiated)	No change (6)	
	Call chief conductor (driver initiated)	Call sent (by PA or radio)	
	Intercom (driver initiated)	PA released Intercom connected	
	Other calls	PA kept (4) Incoming call received (5)	

On-going call	New call	Result	Comment
Intercom (over radio link)	Emergency (driver initiated)	Intercom released Emergency sent	
	Public Address (driver initiated)	Intercom released PA connected	
	Call chief conductor (driver initiated)	Call sent (by PA or radio)	
	Intercom (driver initiated)	No change	
	Call controller (all types)	Intercom released Call sent	
	Other calls	Intercom released Call received	
Intercom (not over radio link)	Emergency (driver initiated)	Intercom released Emergency sent	
	Public Address (driver initiated)	Intercom released PA connected	
	Call chief conductor (driver initiated)	Call sent (by PA or radio)	
	Intercom (driver initiated)	No change	
	Other calls	Intercom kept (4) Incoming call received (5)	

Key:

1. Except broadcast
2. Radio call transferred to the loudspeaker
3. No change if no UIC Intercom link
4. On handset
5. On loudspeaker
6. No access if PA is busy by other
7. Lead driver only

Note: Change Network and Registration/Deregistration are not possible during a call.

Table 5A-1: Call arbitration rules

5A.2 Call termination of outgoing calls table

Type of call	Replacing handset	Clearing call	Notes
Point-to-point	Call terminated	Call terminated	(1)
Multi-party call (normal)	Call terminated	Call terminated	(1)
Voice Broadcast call (normal)	Call terminated	Call terminated	(1)
Group call (normal)	Call terminated	Call terminated	(1)
Multi-party call (other drivers same train)	Voice to loudspeaker	Call terminated	(2)
Voice Group call (emergency)	Voice to loudspeaker	Call terminated	(2) (3)

- (1) Action by the driver on using the "Emergency", "Intercom" or "Public Address" functions has the same effect as activating the 'Call clear' procedure
- (2) If the driver activates the "Intercom" or "Public Address" procedures, the emergency call is transferred to the loudspeaker.
- (3) Call can also be cleared by the Controller.

Table 5A-2: Effect of handset replacement/call clearing - outgoing calls

5A.3 Call termination of incoming calls table

Type of call	Replacing handset	Clearing call	Notes
Point to point	Call terminated	Call terminated	(1)
Multi-party call (normal)	Leave the call (call still remains ongoing between other parties if more than one user remains in the call)	Leave the call (call still remains ongoing between other parties if more than one user remains in the call)	(1)
Voice Broadcast call (normal)	Voice to loudspeaker	Leave call	(1)
Voice Group call (normal)	Voice to loudspeaker	Leave call	(1)
Multi-party call (other drivers same train)	Voice to loudspeaker	No change (*)	(2)
Group call (emergency)	Voice to loudspeaker	No change (*)	(2)

- (*) Leave call is acceptable too, if easier to achieve. In the case of emergency calls, the information of the action shall be reported by the confirmation message.
- (1) Action by the driver on using the "Emergency", "Intercom" or "Public Address" functions has the same effect as activating the 'Call clear' procedure
- (2) If the driver activates the "Intercom" or "Public Address" procedures, the emergency call is transferred to the loudspeaker.

Table 5A-3: Effect of handset replacement/call clearing - incoming calls

6 General purpose radio

6.1 Introduction

6.1.1 This section identifies the EIRENE applications which may be used in the General purpose radio and the functionality to be provided by the General purpose radio is detailed. (I)

6.2 System components

6.2.1 The logical architecture of the General purpose radio is illustrated in figure 6-1. (I)

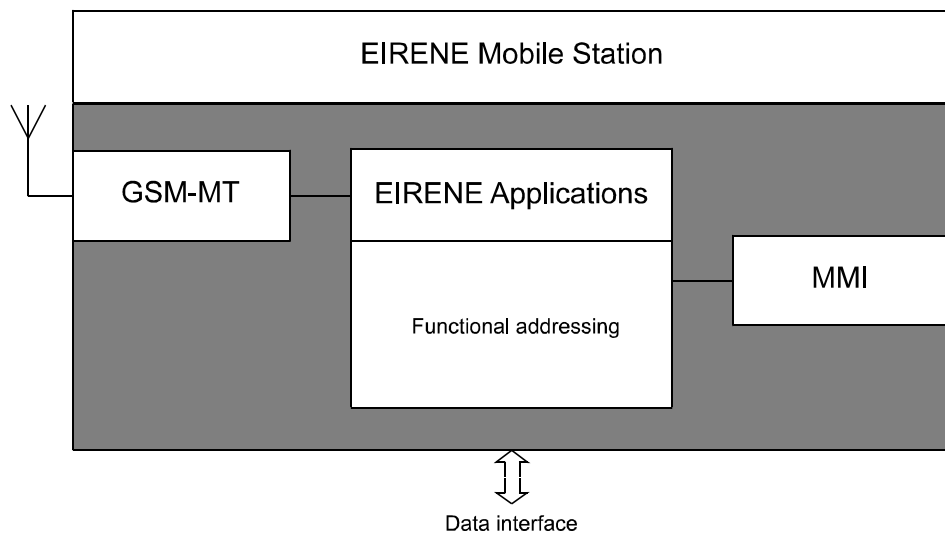

Note: this figure only shows mandatory applications – for a full list see table 4-6

Figure 6-1: Logical General purpose radio architecture and interfaces

6.2.2 A standard data interface shall be provided to allow a computer to be connected to the radio. (M)

6.2.3 The General purpose radio shall operate as a standard GSM terminal, supplying mobile services as defined in section 4. (M)

6.3 General purpose radio functions

Switch radio on

6.3.1 Automatic self-testing of the radio shall use the GSM IMSI attach procedure. (M)

6.3.2 Upon switch on, once the radio is connected to a mobile network, it shall be able to receive all calls made using the MSISDN or appropriate group call number. (M)

Register and deregister functional number

- 6.3.3 It shall be possible to register and deregister a functional number by the user entering his functional number, which is transmitted to the ground along with the subscriber's IMSI, using USSD (see section 11). (M)

6.4 Environmental and physical

- 6.4.1 The full environmental and physical specification of the General purpose shall be as close as possible to that of a Commercial-Off-The-Shelf (COTS) GSM mobile whilst adhering to the specifications provided in section 4. (M)

Climatic conditions

- 6.4.2 The General purpose radio shall comply with the core climatic conditions defined in section 4. (M)

Physical conditions

- 6.4.3 SIM cards should be fixed into the radio to protect against accidental loss. (O)

Mechanical conditions

- 6.4.4 No specific mechanical requirements need to be placed upon the General purpose radio over and above those defined in section 4. (I)

Electrical

- 6.4.5 General purpose radios shall be equipped with rechargeable batteries capable of providing a minimum of eight hours operation over the temperature range +18°C to +25°C from a single charge, based on the following cycle (see section 4.5.21): (M)

- point-to-point calls 20%;
- group calls 5%;
- standby 75%.

- 6.4.6 Changing the battery shall not result in the loss of data stored in the radio. (M)

- 6.4.7 The General purpose radio shall be suitable for use with a car adapter kit. (M)

Electromagnetic Compatibility

- 6.4.8 The General purpose radio should comply with [EN 50081] (generic EMC for residential, commercial and light industry). (O)

Testing procedures

- 6.4.9 No specific testing procedures need to be used on the General purpose radio over and above those given in section 4. (I)

PAGE LEFT INTENTIONALLY BLANK

7 Operational radio

7.1 Introduction

7.1.1 This section identifies the EIRENE applications which may be used in the Operational radio and the functionality to be provided by the Operational radio is detailed. (I)

7.2 System components

7.2.1 The logical architecture of the Operational radio is illustrated in figure 7-1. (I)

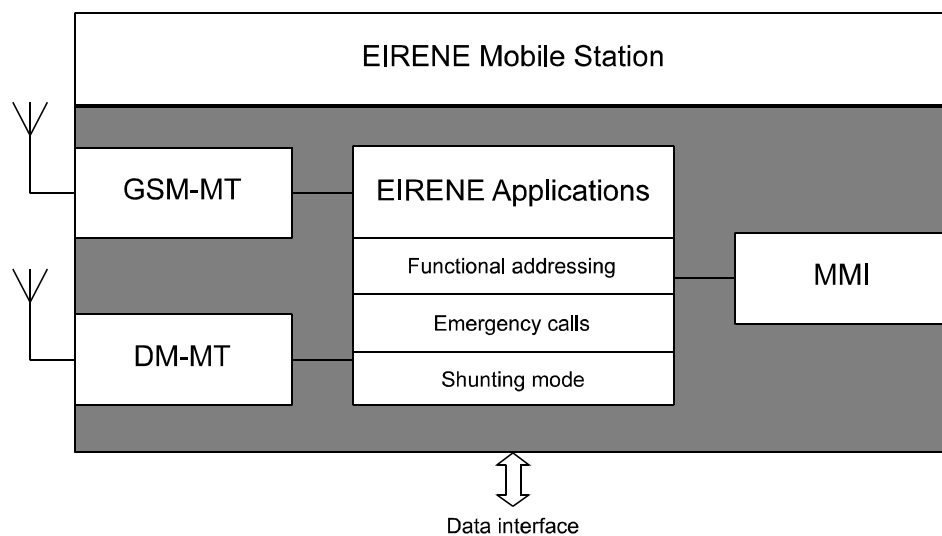

Note: the provision of direct mode is optional

Note: this figure only shows mandatory applications – for a full list see table 4-6

Figure 7-1: Logical Operational radio architecture and interfaces

7.2.2 A standard data interface shall be provided to allow a computer to be connected to the radio. (M)

7.2.3 The Operational radio shall operate as a standard GSM terminal, supplying mobile services as defined in section 4. (M)

7.3 Operational radio functions

Switch radio on

7.3.1 Automatic self-testing of the radio shall use the GSM IMSI attach procedure. (M)

7.3.2 Upon switch on, once the radio is connected to a mobile network, it shall be able to receive all calls made using the MSISDN or appropriate group call number. (M)

Register and deregister functional number

- 7.3.3 It shall be possible to register and deregister a functional number by the user entering his functional number, which is transmitted to the ground along with the subscriber's IMSI, using USSD (see section 11). (M)

Call controller

- 7.3.4 Upon receipt of the call establishment request, the radio shall retrieve the stored number for the appropriate controller from the SIM or other storage location. (M)
- 7.3.5 Once an appropriate number has been obtained, the radio shall initiate a call to this number with 'Railway operation' priority (see section 10.2). Any functional number associated with the user shall be passed to the network using UUS1 (see section 11.5). (M)

Send/receive Railway emergency call

- 7.3.6 Activation of the 'Railway emergency call' function shall cause the radio to initiate a Railway emergency call as defined in section 13. (M)
- 7.3.7 The calling user's functional number, if there is one, shall be passed to the network using UUS1. (M)

Enter/leave direct mode

- 7.3.8 The Operational radio should support direct mode communications as defined in section 15. (O)

Enter/leave shunting mode

- 7.3.9 The Operational radio should support shunting mode communications as defined in section 14. (O)

7.4 Shunting radio requirements

- 7.4.1 The requirements for shunting operations are detailed in section 14. (I)

7.5 Environmental and physical

- 7.5.1 The Operational radio shall comply with the basic standards defined for all EIRENE mobile equipment in section 4. In addition, the Operational radio is specified to allow its use in the operating environment experienced on the operational railway (eg shunting and maintenance), with the specifications in this section taking priority over those in section 4 where any discrepancy is identified. (M)

Climatic conditions

- 7.5.2 The Operational radio shall cope with rapid temperature fluctuations of up to 3°C/second. (M)
- 7.5.3 The Operational radio shall be capable of withstanding exposure to extreme environmental conditions [IEC 721 part 1]. (M)

Physical conditions

- 7.5.4 The Operational radio shall conform to IP 54 [IEC 529/EN 60529] as a minimum. (M)
- 7.5.5 SIM cards shall be fixed into the radio such that they can only be removed by the use of a tool. (M)

Mechanical conditions

- 7.5.6 The Operational radio shall be capable of withstanding the following shocks: (M)
- semi-sinusoidal shocks of up to 5g for up to 100ms under normal conditions;
 - shocks of up to 10g for up to 5ms under exceptional conditions;
 - free fall from 1.0m.

Electrical

- 7.5.7 The Operational radio user shall be protected against all electrical hazards arising from the mobile equipment as defined in [EN 50153]. (M)
- 7.5.8 Operational radios shall be equipped with rechargeable batteries capable of providing a minimum of eight hours operation over the temperature range -10°C to +55°C from a single charge, based on the following cycle (see section 4.5.21): (M)
- point-to-point calls 20%;
 - group calls 60%;
 - standby 20%.

- 7.5.9 Changing the battery shall not result in the loss of data stored in the radio. (M)
- 7.5.10 The Operational radio shall be suitable for use with a car adapter kit. (M)

Electromagnetic compatibility

- 7.5.11 The Operational radio should comply with [EN 50081 part 2] (generic EMC for the industrial environment). (O)

Testing procedures

- 7.5.12 No specific testing procedures need to be used on the Operational radio over and above those given in section 4. (I)

PAGE LEFT INTENTIONALLY BLANK

8 Controller equipment specifications

8.1 General

8.1.1 Functional requirements relating to controller equipment specifications can be found in the EIRENE Functional Requirements Specification [EIRENE FRS]. (I)

8.2 Termination of VGCS/VBS calls

8.2.1 An entitled controller may terminate a VGCS/VBS call based on DTMF signalling [EN 301 515, Index [4] & [5]]. (I)

8.2.2 To terminate a VGCS/VBS call by DTMF signalling, the 3-digit sequence “***” shall be used. (M)

8.2.3 In order to minimise the discomfort caused by the DTMF tone added in the voice channel, the duration of the tone generated by the fixed line dispatcher shall be $70\text{ms} \pm 5\text{ms}$, and there shall be a minimum gap of 65ms between each tone. (M)

8.3 Muting and unmuting for VGCS calls

8.3.1 Muting and unmuting shall be in line with [EN 301 515, Index [4]]. (M)

8.3.2 A group call controller who wishes to start talking (except in the case of an originator, a joiner or a re-joiner speaking for the first time⁵) shall indicate his wish, for example by pressing the PTT button, whereupon the 3-digit DTMF sequence “###” shall be transferred. (M)

8.3.3 The terminal of the controller should receive a single DTMF grant tone “#” of duration $100\text{ms} \pm 5\text{ms}$ sent by the network if it has detected the 3-digit DTMF sequence “###” and if the controller was not previously talking. (O)

8.3.4 Any group call controller who wishes to stop talking shall indicate his wish, for example by releasing the PTT button, whereupon the 3-digit DTMF sequence “***” shall be transferred. (M)

8.3.5 The duration of each tone (see 8.3.2 and 8.3.4) added in the voice channel, shall be $70\text{ms} \pm 5\text{ms}$, and there shall be a minimum gap of 65ms between each tone. (M)

⁵ A controller as a group call originator, joiner and re-joiner speaking for the first time can speak directly without any indication of his wish.

PAGE LEFT INTENTIONALLY BLANK

9 Numbering plan

9.1 General

9.1.1 International standardisation of the numbering plan is required to ensure interworking between networks. Furthermore, standardised allocation of numbers to subscribers is likely to facilitate schemes for identification, barring etc. (I)

9.1.2 This section addresses the following: (I)

- numbering plan requirements;
- numbering plan limitations;
- types of numbers;
- EIRENE numbering plan;
- short dialling codes;
- group addresses.

9.1.3 The precise details of the numbering plan to be chosen for particular railways will depend upon the railway network configuration, its interconnection with other railway networks and its interconnection with public telecommunication networks. Equipment design must therefore be such as to give maximum flexibility in numbering arrangements. However, it may be generally assumed that numbers (excluding access prefixes) will not exceed 15 digits in length and will consist entirely of the digits 1 to 9 and 0. (I)

9.1.4 Characters * and # may be used locally to gain access to special facilities such as short code dialling. However, these arrangements do not form part of the network numbering plan. (I)

9.1.5 Procedures for handling the relationship between EIRENE Numbers and MSISDN numbers (ie registration, deregistration and re-registration) are specified in section 11. (I)

9.1.6 Each railway should have appropriate call-barring facilities to prevent unintended access to the GSM-R network by non-authorised users. (O)

9.2 Numbering plan requirements

Use of Train Number

9.2.1 Within each GSM-R network, each Train Number shall be unique for the period of the journey. (M)

9.2.2 Every On-Train Function shall be identified by a standard code and shall conform to the list of functions given in Appendix 9A of this section. (M)

- 9.2.3 All Train Function Numbers and their associated MSISDN numbers shall be stored in the same routing database, which is the database of the GSM-R network in which the train is currently operating. (M)

Use of Engine Number

- 9.2.4 Every On-Engine Function shall be identified by a standard code and shall conform to the list of functions given in Appendix 9A of this section. (M)

- 9.2.5 The Engine Function Number(s) and associated MSISDN numbers shall at any time be stored as an entry in the routing database of the home GSM-R network⁶ of the engine. (M)

Use of Coach Number

- 9.2.6 The Coach Function Number(s) and associated MSISDN number(s) shall at any time be stored as an entry in the routing database of the home GSM-R network of the coach. (M)

Use of Shunting Team, Maintenance Team or Train Controller Number

- 9.2.7 Every Function shall be identified by a standard code and shall conform to the list of functions given in Appendix 9A of this section. (M)

- 9.2.8 The functional numbers of the Shunting Team Members, Maintenance Team Members and Train Controller (and any associated MSISDN numbers) shall be stored as entries in the routing database of the home GSM-R network. (M)

Use of MSISDN number

- 9.2.9 Implementation of the EIRENE numbering plan shall not prohibit any authorised caller from using the MSISDN number where known, thus enabling mobiles to be assigned to particular personnel where this is appropriate. (M)

Use of group call Service Areas

- 9.2.10 Service areas shall be defined within each railway network. (M)

- 9.2.11 The numbering of Service Areas for group calls and broadcast calls shall be made in accordance with GSM Technical Specifications [EN 301 515, Index [21] & [4]] and [EN 301 515, Index [22] & [5]] respectively. (M)

⁶ The home GSM-R network is the mobile network to which the mobile on the engine is subscribed.

9.3 **Numbering plan limitations**

- 9.3.1 The EIRENE network can not be considered as a fully private network, as some parts of either the mobile or fixed networks may be provided by public operators. This leads to certain restrictions on the implementation of a numbering plan. These restrictions are given below. (I)

Number allocation

- 9.3.2 To achieve integration of the EIRENE numbering plan with the national public numbering plan, telephone numbers have to be allocated by the various numbering regulatory bodies on a national basis. If functional numbers are to be used outside the EIRENE network, they will require either a public number allocation or, alternatively, an EIRENE Network Access Number (ENAN) may be used as described in 9.11 (I)
- 9.3.3 Each national railway should obtain a public numbering allocation for MSISDN numbers from the relevant regulatory bodies. (O)
- 9.3.4 The EIRENE numbering plan shall be standardised to allow interoperability and shall be implemented as a private numbering plan within the GSM-R network. (M)

Use of alphanumerical numbers

- 9.3.5 In some countries Train Numbers are alphanumeric. These numbers do not comply with a numbering plan that can be interpreted by telephone switches and are therefore not supported by the call routing solution given in section 11. (I)
- 9.3.6 If alphanumerical numbering is required within a railway network, then these numbers may either be translated at the user terminal into a subscriber number or conveyed between the calling party and a routing database using a nationally determined approach. (I)

9.4 **Types of numbers**

- 9.4.1 Within the GSM-R network, the user shall be able to dial the following types of numbers: (M)
- **National EIRENE Number (NEN)**: this number is used to route a call from the calling party to a called party registered within the same GSM-R network;
 - **International EIRENE Number (IEN)**: this number is used to route a call from the calling party to a called party registered within another GSM-R network;
 - **MSISDN numbers**: the number used by a subscriber of a public fixed (or mobile) network for calling a mobile station of a GSM PLMN;
 - **Short Dialling Code (SDC)**: this number is used to allow 'speed dialling' functionality.

9.4.2 In addition, Breakout Codes (BCs) shall be used to allow users within the GSM-R network to access external numbers. (M)

9.4.3 Access from the GSM-R network to external networks shall be as detailed in section 9.10. (M)

9.5 Use of National EIRENE Numbers

9.5.1 National EIRENE Numbers are used to set up calls within a single GSM-R network. (I)

9.5.2 Every railway network shall consider a number as a National EIRENE Number (NEN) unless the number is preceded by an International Code, identifying another GSM-R network. (M)

Structure of National EIRENE Number

9.5.3 The National EIRENE Number shall consist of three distinct parts, as shown in figure 9-1: (M)

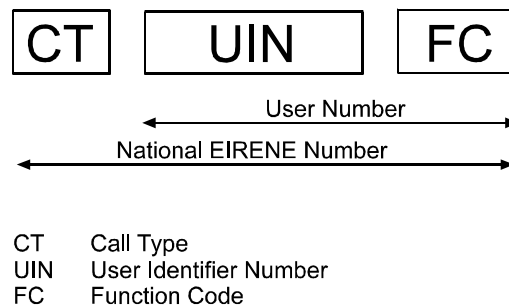

Figure 9-1: National EIRENE Number structure

1) Call Type:

The Call Type (CT) prefix is used to distinguish between the different types of User Numbers that are allowed within the national EIRENE numbering plan. It is an indication to the network of how to interpret the number dialled. (I)

2) User Identifier Number:

The User Identifier Number (UIN) shall be one of the following numbers (as identified by the CT): (M)

- **Train Number (TN):** a number given to a train by operational staff for a particular journey. This number shall be unique for the duration of the journey.

- **Note.** For certain Train Numbers (e.g. 1234 and 123), a risk exists when dialling a number by keying in individual digits e.g. by the dispatcher. In this circumstance the risk of connecting to an un-intended train exists if there is a delay between keyed-in digits. There is no risk of ambiguity if block dialling is employed.
- **Engine Number (EN):** a unique number given to a tractive unit to identify it permanently. The UIC has introduced a uniform identification marking system for tractive stock crossing frontiers [UIC 438-3]. In order to call a particular locomotive, it shall be possible to call a number associated with the tractive unit's stock number. The actual number of the unit, which shall be used as the EN, is based on the complete identification number.
- **Coach Number (CN):** a unique number given to a coach (which is not a tractive unit) to identify it permanently. The UIC has introduced a uniform identification marking for passenger rolling stock [UIC 438-1]. In order to call a particular coach it shall be possible to call a number associated with the vehicle marking. The total vehicle marking consists of 12 digits. The actual number of the coach is denoted by seven digits (positions 5 to 11 of the complete vehicle marking), which shall be used as the CN⁷.
- **Shunting Team Location Number (STLN)**
- **Maintenance Team Location Number (MTLN)**
- **Train Controller Location Number (TCLN)**
- **Group Location Number (GLN)**
- **Mobile Subscriber Number (MSN)**

3) **Function Code:**

The Function Code (FC) is used as an identification of, for example, the person or equipment on a particular train, or a particular team within a given area.

National EIRENE Numbering Plan

9.5.4 The contents of the fields of a National EIRENE Number shall be as defined below: (M)

1) Call Type (CT)

This prefix defines how to interpret the User Number that follows. It shall consist of one or two digits as defined in table 9-1.

⁷ In order to prevent duplication of numbering, as each railway is free to allocate the coach number leading to number uniqueness per country only, the Owning or registering Railway code should be added as the first digits.

Digit	Use
1	Reserved for short codes (see section 9.8)
2	Train Function Number (ie TN + FC)
3	Engine Function Number (ie EN + FC)
4	Coach Number (ie CN + FC)
50	Group calls
51	Broadcast calls
52-55	Reserved for international use
56-59	Reserved for national use
6	Maintenance and shunting team members
7	Train controllers
8	Mobile Subscriber Number
9	Reserved for breakout codes (see section 9.10) and national use
0	Reserved for access to public or to other GSM-R networks (see section 9.10)

Table 9-1: Call Type field format

2) User Number (UN)

The UN is variable in length and depends on the information on which it is based. The following formats are defined:

- **Train Function Numbers (TFN)** shall take one of the forms as defined in table 9-2. Leading zeros shall be used in those situations where the train number is less than five digits.

Train Number	Use
0000XFF	train number with one significant digit
000YXFF	train number with two significant digits
00YXXFF	train number with three significant digits
0YXXXFF	train number with four significant digits
YXXXXFF	train number with five significant digits
XXXXXXFF	train number with six significant digits
XXXXXXXXFF	train number with seven significant digits
XXXXXXXXXXFF	train number with eight significant digits
	<i>FF - Function Code as defined in Appendix A table 9A-1</i>
	<i>Y not equal to 0</i>

Table 9-2: UN - Train Function Number field format

- **Engine Function Numbers (EFN)** shall take the format as defined in table 9-3.

Engine Number	Use
XXXXXXXXXXFF	XXXXXXXXXX : number of powered unit allocated by each Railway FF : Function Code as defined in Appendix A table 9A-1

Table 9-3: UN - Engine Function Number field format

- **Coach Function Numbers (CFN)** shall take the format as defined in table 9-4.

Coach Number	Use
RRXXXXXXXXXXFF	RR : owning or registering railway code XXXXXXXX : vehicle number allocated by each Railway FF : Function Code as defined in Appendix A table 9A-1

Table 9-4: UN - Coach Function Number field format

- **Maintenance and Shunting Team Members.** The UIN field format for calls to shunting teams and maintenance teams shall consist of a Location Number (LN), which identifies the location where the called party is registered, followed by a Function Code (FC). The Location Number shall consist of 5 digits and shall be assigned on a national basis. The Function Code shall consist of 4 digits. The first digit of the FC is related to the Team Type (TT) and is specified by table 9-5.

Team Type	Description
1 – 3	<i>Reserved for international use</i>
4	<i>Reserved for national use</i>
5	Shunting Team
6 – 9	<i>Reserved for national use</i>
0	<i>Reserved for international use</i>

Table 9-5: UIN – Team Type field format

The composition of the Function Code field for calls to shunting teams and maintenance teams shall be as defined in table 9-6.

FC	Function description
TT,Y,XX	Team type, team member function and team number TT : team type Y : team member function XX : team number As defined in Appendix 9A table 9A-2

Table 9-6: Function Code field format for CT=6

- **Train Controllers.** The UIN field for calls to train controllers shall be a Location Number (LN) which identifies the location where the called party is registered. The Location Number shall consist of 5 digits and shall be assigned on a national basis.

The FC field for calls to train controllers shall consist of two digits and be as defined in table 9-7.

FC	Function description
01	Primary controller
02	Secondary controller
03	Power supply controller
04 - 10	Reserved for international use
11-99	Reserved for national use

Table 9-7: Function Code field format for CT=7

- **Mobile Subscriber Number (MSN).** The UN of the MSN shall consist of the Subscriber Number.
- **Group and broadcast calls.** The UIN field format for group calls shall be a Service Area (SA) indicator, which identifies the area in which the group call is to be active. Each Service Area shall be allocated on a national basis. In network boundary areas, the Service Area shall be allocated on a bilateral basis. (See also subsection 9.9.)

The FC field format for group calls shall consist of three digits and be as defined in table 9-8.

FC	Function Description
1xx	Reserved for national use
200	“All trains group” in the context of call other drivers in the same area (section 5.3.3)
2xx	Reserved for national use
299	Train groups: Emergency call
3xx	Reserved for national use
4xx	Reserved for national use
500	Shunting groups: Default group
501 – 529	Shunting groups: Dedicated shunting groups
530	Station and security staff: Default group
53x	Station and security staff: Reserved for international use
539	Station and security staff: Emergency call
54x	Reserved for international use
55x	Reserved for international use
560	Trackside maintenance groups: Default group
56x	Trackside maintenance groups: Reserved for international use
569	Trackside maintenance groups: Emergency call
570	Controller groups: Default group
57x	Controller groups: Reserved for international use
579	Controller groups: Emergency call
580	Reserved for international use
59x	Reserved for international use
599	Shunting groups: Emergency call
6xx	Reserved for national use
7xx	Reserved for national use
8xx	Reserved for national use
9xx	Reserved for national use
0xx	Reserved for national use

Table 9-8: Function Code field format for CT=5

9.6 Use of International EIRENE Numbers

- 9.6.1 International EIRENE Numbers are used for calls between GSM-R networks. Additional fields are added to the National EIRENE Number as routing indicators. The use of such indicators is discussed in subsection 9.10. (I)
- 9.6.2 GSM-R networks shall recognise International EIRENE Numbers starting with the IC of the GSM-R network in which the calling party is currently operating as National EIRENE Numbers. (M)

Structure of International EIRENE Number

- 9.6.3 The International EIRENE Number shall consist of three distinct parts, as shown in figure 9-2: (M)

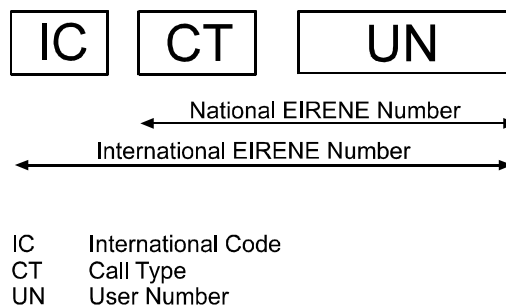

Figure 9-2: International EIRENE Number structure

- International Code (IC), which shall be used to route calls to the appropriate GSM-R network;
- National EIRENE Number (NEN), which consists of the combination of Call Type and User Number and which is used to identify the called party.

International EIRENE Numbering plan

- 9.6.4 The fields of an International Functional Number shall be defined as follows: (M)

1) **International Code (IC)**

The International Code field shall consist of three digits and shall be based on the [ITU-T E.164] country code (XCC or CCC), allocated by the UIC on a network-by-network basis.

2) **National EIRENE Number (NEN)**

The format of the National EIRENE Number field shall be as defined in subsection 9.5.

9.7 Use of MSISDN numbers

- 9.7.1 At least one MSISDN number shall be allocated to each mobile station. (M)
- 9.7.2 The structure of the MSISDN numbers shall comply with GSM Technical Specification [GSM 03.03]. (M)

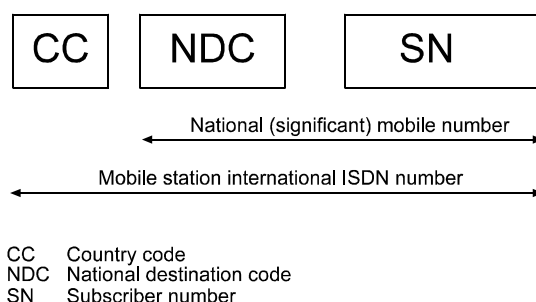

Figure 9-3: Number structure of MSISDN number

- 9.7.3 Within each GSM-R network, the following relationships between the MSISDN Subscriber Number and the National EIRENE Number can be identified:
- the MSISDN Subscriber Number shall be equal to the National EIRENE Number for Call Type = 8; (M)
 - the MSISDN number may be equal to the National EIRENE Number for any other Call Type. (O)
- 9.7.4 It shall be possible for authorised subscribers of fixed and mobile networks to call mobiles using the appropriate MSISDN number. (M)
- ## 9.8 Use of Short Dialling Codes
- 9.8.1 For certain functions, standardised short codes shall be implemented for mobile originated calls. (M)
- 9.8.2 Each short dialling code shall consist of four digits. (M)
- 9.8.3 Short dialling codes shall start with the first digit equal to 1 (ie CT=1). (M)
- 9.8.4 The short dialling codes can be defined on a national basis, but it is essential that certain codes be used on an international basis in order to achieve interoperability. These codes shall be as given in table 9-10. (M)

Code	Description
10(00-99)	Reserved for national use
11(00-19)	Reserved for national use
112X	Not used (note: 112 reserved for public emergency)
11(30-99)	Reserved for national use
12XX*	Route to most appropriate primary controller
13XX*	Route to most appropriate secondary controller
14XX*	Route to most appropriate power supply controller
15XX*	Route to most appropriate ERTMS/ETCS RBC
1612	High priority call confirmations including railway emergency calls (see section 13)
16YY**	Reserved for international use
1700	Driver Safety Device
17(01-99)	Reserved for international use
18(00-99)	Reserved for national use
19(00-99)	Reserved for national use

* XX may be used to provide supplementary location information within a cell. Where no additional information is available the default value shall be 00.

** YY is not 12.

Table 9-10: Internationally defined short codes

- 9.8.5 In addition, the network shall support the special short codes as defined in table 9-11. (M)

Code	Description
112	European emergency number

Table 9-11: Special short codes

9.9 Use of group addresses

- 9.9.1 Standardisation of UIC group addresses is required to provide interoperability between the fixed railway networks within the GSM-R network. (M)

- 9.9.2 The group address consists of a Service Area (5 digits) and a Function Code (3 digits) and has a Call Type 5 (see table 9-1). (M)
- 9.9.3 The Service Area shall be defined on a national basis. (M)
- 9.9.4 In network boundary areas, the Service Area shall be allocated on a bilateral basis. (M)
- 9.9.5 Function Codes shall be defined within the framework given in table 9-8 on an international basis. (M)

9.10 Access to external networks

- 9.10.1 Access to other GSM-R networks shall be possible by using a Breakout Code (BC) as part of the dialled number. (M)
- 9.10.1i Access to other GSM-R networks may be possible by using an Access Code (AC) as part of the dialled number if the NSN (National Significant Number) following the CC (Country Code) is assigned by the national telecommunication regulator to the GSM-R operator. (O)

Note: NSN=NDC (National Destination Code) + SN (Subscriber Number)

- 9.10.1ii The BC for access to other GSM-R networks is defined in table 9-12a, and is followed by the full international EIRENE number of the called party. (M)

Breakout Code	Network
900	Other GSM-R network (International EIRENE Numbering plan as defined in subsection 9.6)

Table 9-12a: Breakout Code (other GSM-R Networks)

- 9.10.1iii The AC for access to other GSM-R networks is defined in table 9-12b, and is followed by the CC + NDC + SN of the other GSM-R network. The number format complies with [ITU-T 164]. (M)

Access Code	Network
00 (or +)	Other GSM-R network (designated by CC + NDC)

Table 9-12b: Access Code (other GSM-R networks)

- 9.10.1iv It is the responsibility of each individual GSM-R operator to acquire a public domain NDC from their national telecommunications regulator. (I)
- 9.10.1v Access to private networks shall be performed by using a BC, defined in table 9-12c. (M)

Breakout Code	Network
901	Gateway to private railway network (private numbering plan)
902 – 909	Reserved for national breakout codes

Table 9-12c: Breakout Codes (private networks)

Note: All other CT9 numbers are reserved for railway national fixed networks and systems.

- 9.10.2 The GSM-R network shall allow users direct access to public networks, subject to call barring restrictions. (M)
- 9.10.3 Where access to public networks is allowed, this shall be performed by using an Access Code (AC), defined in table 9-13, followed by the international or national number of the called subscriber as defined in [ITU-T 164]. (M)
- 9.10.4 Deleted.

Access Code	Network
00 (or +)	Calls to international public networks
0	Calls to national public networks (note: "0" is followed by a digit ≠ "0")

Table 9-13: Access Codes for calls to public networks

9.11 Calls from external networks to the GSM-R network

- 9.11.1 Access to the GSM-R network should be performed by dialling an EIRENE Network Access Number (ENAN)⁸, followed by the relevant National or International Functional Number as defined in subsections 9.5 and 9.6 respectively. (O)

⁸ The ENAN may be either an NDC in the case of direct dialling of EIRENE numbers, or a nationally defined telephone number allowing indirect dialling through public networks.

9.11.2 Provision should be made to prevent unauthorised calls to mobiles from outside the GSM-R network. (O)

9A Function Codes

9A.1 Function Codes identify the actual user of a mobile. (I)

9A.2 The Function Codes used in association with the Train Function Number (CT=2), Engine Function Number (CT=3) and Coach Function Number (CT=4) shall conform to table 9A-1. (M)

Function Code	Function description
00	Spare alarm
01	Leading driver
02 – 05	Other drivers
06	Fax
07	Intercom
08	Public address
09	Reserved for international use
10	Chief conductor
11	Second conductor
12	Third conductor
13	Fourth conductor
14 – 19	Reserved for international use (train crew)
20	Catering staff chief
21 – 29	Reserved for international use (catering staff)
30	Railway security services chief
31 – 39	Reserved for international use (security services)
40	ERTMS/ETCS
41-49	Reserved for international use (ERTMS/ETCS)
50	Train-borne recorder
51	Diagnostics
52	Train data bus
53	Train location system
54-59	Reserved for international applications for on train equipment
60	Pre-recorded passenger info
61	Displayed passenger information unit
62 – 69	Reserved for international use (passenger services)
70 – 79	Reserved for international use
80 – 99	Reserved for national use

Note: Function Codes are reserved for international applications except when shown as “Reserved for national use”.

Table 9A-1: Function Code field for CT=2, 3 and 4

9A.3 The Function Codes used in association with Maintenance Services Team Numbers (CT=6) shall conform to table 9A-2. (M)

Function Code	Function description
TT,y,xx TT=1-4	Reserved for international use
TT,y,xx TT=5	y = 0 Shunting leader 1 – 3 Shunting team member 4 Train driver 5 – 9 Reserved for national use xx = 00 Reserved 01 – 29 Dedicated shunting groups* 30 – 99 Reserved
TT,y,xx TT=6-9	Reserved for national use
TT,y,xx TT=0	Reserved for international use

* As defined in table 9-8, FCs 501 – 529 provide dedicated shunting groups 01 – 29

Table 9A-2: Function Code field for CT=6

9B Numbering plan overview

- 9B.1 This appendix provides an overview of the numbering plan as defined in this section of the EIRENE SRS, detailing the allocation of numbers within the National and International EIRENE Numbering plan. (I)

BC	IC	CT	UIN	FC	Comment
		1	0 0 0		Reserved for national use
		:	:		:
		1	0 9 9		Reserved for national use
		1	1 2 X		Not used
		1	2 X X		Route to most appropriate primary controller
		1	3 X X		Route to most appropriate secondary controller
		1	4 X X		Route to most appropriate power supply controller
		1	5 X X		Route to most appropriate ERTMS/ETCS RBC
		1	6 1 2		High priority call confirmations including railway emergency calls
		1	6 Y Y		Reserved for international use
		1	7 0 0		Driver Safety Device
		1	7 Y Y		Reserved for international use
		1	8 Y Y		Reserved for national use
		1	9 Y Y		Reserved for national use
		2	0 0 0 0 X	F F	Train Function Number; TN consists of one digit
		2	0 0 0 Y X	F F	Train Function Number; TN consists of two digits
		2	0 0 Y X X	F F	Train Function Number; TN consists of three digits
		2	0 Y X X X	F F	Train Function Number; TN consists of four digits
		2	Y X X X X	F F	Train Function Number; TN consists of five digits
		2	X X X X X X	F F	Train Function Number; TN consists of six digits
		2	X X X X X X X	F F	Train Function Number; TN consists of seven digits
		2	X X X X X X X X	F F	Train Function Number; TN consists of eight digits
		3	X X X X X X X X	F F	Engine Function Number
		4	R R X X X X X X X X	F F	Coch Function Number
		5 0	S S S S S	1 X X	Group call - Reserved for national use
		5 0	S S S S S	2 0 0	Group call - Train groups: Default group
		5 0	S S S S S	2 X X	Group call - Reserved for national use
		5 0	S S S S S	2 9 9	Group call - Train groups: Emergency call
		5 0	S S S S S	3 X X	Group call - Reserved for national use
		5 0	S S S S S	4 X X	Group call - Reserved for national use
		5 0	S S S S S	5 0 0	Group call - Shunting groups: Default group
		5 0	S S S S S	5 0 1	Group call - Shunting groups: Team number 01
		5 0	S S S S S	:	:
		5 0	S S S S S	5 2 9	Group call - Shunting groups: Team number 29
		5 0	S S S S S	5 3 0	Group call - Station and security staff: Default group
		5 0	S S S S S	5 3 X	Group call - Station and security staff: Reserved for international use
		5 0	S S S S S	5 3 9	Group call - Station and security staff: Emergency call
		5 0	S S S S S	5 4 X	Group call - Reserved for international use
		5 0	S S S S S	5 5 X	Group call - Reserved for international use
		5 0	S S S S S	5 6 0	Group call - Trackside maintenance groups: Default group
		5 0	S S S S S	5 6 X	Group call - Shunting groups: Reserved for international use
		5 0	S S S S S	5 6 9	Group call - Trackside maintenance groups: Emergency call
		5 0	S S S S S	5 7 0	Group call - Controller groups: Default group
		5 0	S S S S S	5 7 X	Group call - Controller groups: Reserved for international use
		5 0	S S S S S	5 7 9	Group call - Controller groups: Emergency call
		5 0	S S S S S	5 8 0	Group call - Reserved for international use
		5 0	S S S S S	5 9 X	Group call - Reserved for international use
		5 0	S S S S S	5 9 9	Group call - Shunting groups: Emergency call
		5 0	S S S S S	6 X X	Group call - Reserved for national use
		5 0	S S S S S	7 X X	Group call - Reserved for national use
		5 0	S S S S S	8 X X	Group call - Reserved for national use
		5 0	S S S S S	9 X X	Group call - Reserved for national use
		5 0	S S S S S	0 X X	Group call - Reserved for national use
		5 1	S S S S S	1 X X	Broadcast call - Reserved for international use
		5 1	S S S S S	2 X X	Broadcast call - Train groups
		5 1	S S S S S	3 X X	Broadcast call - Station and security staff groups
		5 1	S S S S S	4 X X	Broadcast call - Reserved for national use
		5 1	S S S S S	5 X X	Broadcast call - Shunting groups
		5 1	S S S S S	6 X X	Broadcast call - Trackside maintenance groups
		5 1	S S S S S	7 X X	Broadcast call - Controller groups
		5 1	S S S S S	8 X X	Broadcast call - Reserved for international use
		5 1	S S S S S	9 X X	Broadcast call - Reserved for international use
		5 1	S S S S S	0 X X	Broadcast call - Reserved for international use
		5 2	:		Reserved for international use
		:	:		:
		5 5	:		Reserved for international use
		5 6	:		Reserved for national use
		:	:		:
		5 9	:		Reserved for national use
		6	L L L L L	1 Y X X	Reserved for international use
		6	L L L L L	2 Y X X	Reserved for international use
		6	L L L L L	3 Y X X	Reserved for international use
		6	L L L L L	4 Y X X	Reserved for national use
		6	L L L L L	5 0 X X	Shunting team - Team leader
				1 X X	Shunting team - Team member #1
				2 X X	Shunting team - Team member #2
				3 X X	Shunting team - Team member #3
				4 X X	Shunting team - Train driver
				5 X X	Reserved for national use
				6 X X	Reserved for national use
				7 X X	Reserved for national use
				8 X X	Reserved for national use
				9 X X	Reserved for national use
		6	L L L L L	6 Y X X	Reserved for national use
		6	L L L L L	7 Y X X	Reserved for national use
		6	L L L L L	8 Y X X	Reserved for national use
		6	L L L L L	9 Y X X	Reserved for national use
		6	L L L L L	0 Y X X	Reserved for international use
		7	L L L L L	0 1	Primary controller
				0 2	Secondary controller
				0 3	Power supply controller
				0 4	Reserved for international use
				:	:
				1 0	Reserved for international use
				1 1	Reserved for national use
				:	:
				9 9	Reserved for national use
		8			Mobile Subscriber Number
		9	0 0		Gateway to other GSM-R network
			0 1		Gateway to private railway network
			0 X		Reserved for national use
		0			Reserved for PSTN Access Codes

Table 9B-1: National Functional Numbering plan overview

10 Subscriber management

10.1 Introduction

10.1.1 In order to provide a consistent level of service in each railway network and, in particular, to ensure interoperability for train drivers and other users roaming between networks, it is important to harmonise subscription details and other information stored in the network. (I)

10.1.2 For the purposes of defining common subscription profiles, a number of subscription types might be used, for example: (I)

- Cab radio;
- on-train radio;
- controller;
- trackside worker;
- general staff;
- data systems;
- administration/management.

10.2 Allocation of priorities

10.2.1 In order to provide a consistent international service, it is necessary to ensure that priorities are allocated consistently across all railways. The following allocation of UIC priority levels to eMLPP priority codes is mandatory: (M)

UIC Priority	Automatic answering*	eMLPP priority designation	Pre-emption (of)
Railway emergency	Y	0	Control-command (safety) and below
Control-command (safety)	Y	1	Public emergency, group calls between drivers in the same area and below
Public emergency and group calls between drivers in the same area	Y	2	Railway operation. Control-command information and below
Railway operation (eg calls from or for drivers and controllers) and Control-command information	Y**	3	Railway information and all other calls
Railway information and all other calls	N	4	-

* Auto answer applies only to voice calls to mobile users as defined in [EN 301 515, Index [27]] (eMLPP)

** Mandatory for cab radio, optional for other user equipment

Table 10-1: Allocation of priorities

10.2.2 Levels 0 – 4 are designed to interwork with the ISDN MLPP service. (I)

10.3 Access classes

10.3.1 User access classes are defined in GSM so that under critical conditions, part of the user population can be barred from accessing the network in order to avoid congestion. However, such barring can be overridden by a user being a member of one or more of the following special access classes: (I)

- 11 open to network operator;
- 12 security services;
- 13 public utilities;
- 14 emergency services;
- 15 network operator staff.

10.3.2 Access classes should not be used under normal network operating conditions, where the GSM eMLPP may be used to provide a better grade of service to certain users. (O)

- 10.3.3 For consistent working on public networks and in international roaming, the use of access classes in a railway network shall comply with the GSM specification. (M)
- 10.3.4 If special access classes (eg 12 - 14) are assigned within a railway's network to certain high priority users, it ought to be noted that when roaming, this will only have an effect on a national public network, subject to bilateral agreement. (I)

10.4 Closed user groups

- 10.4.1 Closed User Groups (CUGs) may be employed by railways as an additional security measure. Such facilities may be particularly important if public network access to the radio system is provided (eg to prevent members of the public calling drivers and drivers calling members of the public). (I)
- 10.4.2 Any implementation of CUGs must take account of requirements for interoperability. (M)

10.5 Network selection

- 10.5.1 SIM cards shall contain a list of authorised networks so that networks shall be displayed (or automatically selected if automatic network selection has been enabled) in the following order of priority (see [MORANE SIM] for more details): (M)
- home EIRENE network;
 - 'foreign' EIRENE networks;
 - non-EIRENE networks (with order of priority predetermined by virtue of international subscriptions and roaming agreements).
- 10.5.1i In order to shorten the duration of the network selection procedure, Mobile Stations designed for use in EIRENE networks shall give preference to the GSM frequency band allocated for railway use (see 3.5.2). (M)
- 10.5.2 The use of "Over The Air" in conjunction with the SIM Application Toolkit [EN 301 515, Index [36]] to update SIM cards in the home network is recommended (see [MORANE SIM] for more details). (I)

10.6 Cell broadcast message identifiers

- 10.6.1 Railway mobiles shall be provided with cell broadcast message identifiers in order to accept SMS-CB messages. (M)

10.7 Encryption and authentication

10.7.1 **Encryption.** Licensing of A5/x encryption algorithms is managed by the GSM Association. (I)

10.7.1i In case of encryption, standardised ciphering algorithms shall be used. (M)

10.7.2 Deleted.

10.7.3 Mobiles shall be capable of operation using algorithms for all countries in which they need to roam. (M)

10.7.4 **Authentication.** Each railway is free to implement its own authentication algorithms without any resulting loss in cross-border interoperability. (I)

11 Functional numbering and location dependent addressing

11.1 Introduction

- 11.1.1 There is a requirement to be able to address communications to a 'functional number' rather than a more permanent subscriber number. Such numbers are generally only associated with a user for a limited period of time. (I)
- 11.1.2 This is an important issue which will affect interoperability and the ability to use public network services. There are specific features of individual railways which make it difficult to develop a concise and universally acceptable system within GSM. (I)
- 11.1.3 To accommodate the different requirements of the individual railways, the following approach has been adopted: (I)
- all responsibility for handling addressing lies with the network infrastructure and other ground based equipment, rather than additional functionality in the mobile;
 - each railway will be responsible for implementing addressing schemes which best meet its needs;
 - national addressing schemes are to use the internationally standardised ground-train protocol, based on a single standardised GSM service, for exchanging information between the ground and mobiles.

11.2 Ground-train addressing

- 11.2.1 The ground-train addressing can be divided into two areas: (I)
- functional addressing of mobile users;
 - location dependent addressing of fixed network users.
- 11.2.2 The first is related to passing information to provide an association between a mobile's subscriber number and its functional number. The latter is concerned with ensuring that calls from a mobile terminal (in particular, Cab radios) are routed to the correct destination (ie primary controller, secondary controller), based on the current location of the mobile. (I)
- 11.2.3 The numbering plan to be used with functional addressing shall be in accordance with the numbering plan given in section 9. (M)

11.3 Functional numbering

General

- 11.3.1 Functional numbering provides the mechanism by which a mobile terminal, or an item of equipment connected to a mobile terminal, can be addressed by a number identifying the function for which it is being used. (I)

- 11.3.2 Mobile access to the functional numbering scheme for registration, deregistration and re-registration shall apply the USSD messages and protocols over the air interface as specified in the GSM Follow-me service. (M)
- 11.3.3 The implementation of functional numbering at a network level is left open for national railways subject to the requirements for interconnecting EIRENE networks identified in section 11.6. (I)
- 11.3.4 Further information may be obtained from [MORANE SSRS, MORANE FA FFFS, MORANE FA FIS]. (I)

Functional number management

- 11.3.5 For communication over the (Um) air interface, the USSD messages and protocols as specified in the GSM Follow-me service shall be used to manage the following types of functional numbers: (M)
- Train number;
 - Engine number;
 - Coach number;
 - Shunting team number;
 - Maintenance team number.
- 11.3.6 It shall be possible to limit user access to functional number registration and deregistration facilities based on each of the types of functional number identified in 11.3.5. (M)
- 11.3.7 Mobile stations shall use the following sequences for the control of the functional number management: (M)

Procedure	Sequence
Interrogation	*#214*SI***#
Registration	**214*SI***#
Deregistration	##214*SI***#
Re-registration Definition in section 11.3.14	**214*SI***# followed by ##214*SI***#
Forced De-registration	##214*SI*88*MSISDN*#

Where SI Supplementary Information represents the International Functional Number (also called the International EIRENE Number), as defined in section 9.6.3.

Note: This table is for information only. The Follow Me service control sequences are based on the USSD specified in [EN 301 515, Index [15]].

- 11.3.8 The network operator shall implement the required functionality to validate the information exchanged between the mobile and network on registration and deregistration. (M)
- 11.3.8i Functionality shall be provided by the system for the operator management of Functional Numbers, including the removal of the relationship between Functional Numbers and MSISDN Numbers. (M)
- 11.3.8ii The use of the forced de-registration mechanism (without notification) to achieve this requirement is acceptable. (I)
- 11.3.8iii The system shall require manual confirmation prior to the removal of the relationship between Engine Number and MSISDN Number. (M)

Registration

- 11.3.9 The result of the registration procedure shall be sent back to the mobile. In the event of a failure, an indication of the cause shall be provided. Information on the outcome shall be provided to the mobile according to [EN 301 515, Index [17]] and [EN 301 515, Index [34]]. (M)
- 11.3.9i In the event of a registration procedure failing owing to the functional number already being registered to another mobile, the Cab radio shall be capable of providing the user with the ability to perform automatically the forced de-registration of the previously registered mobile and the registration of this functional number to the user's mobile. This shall result in the following sequence of actions being performed by the user's Cab radio (see 11.3.7 for details of message structure): (M)
 - 1. Send interrogation message (from mobile to network).
 - 2. Receive MSISDN (from network to mobile).
 - 3. Send a forced de-registration message (from mobile to network).
 - 4. Receive the answer (from network to mobile).
 - 5. Send a registration message (from mobile to network).
 - 6. Receive the answer (from network to mobile).
 - 7. Inform the user whether the registration of the functional number to the user's mobile was successful (performed by the mobile).
- 11.3.9ii The functionality described in 11.3.9i should also be available for other types of mobiles. (O)
- 11.3.9iii In the cases described in 11.3.9i and 11.3.9ii, national rules may dictate that, prior to or instead of performing the sequence described in 11.3.9i steps 1-7, the user shall perform a specified action (e.g. call a dispatcher in the case of drivers). (I)
- 11.3.9iv The sequence described in 11.3.9i steps 1-7 may be interrupted or may require additional user action such as a confirmation. (I)

Deregistration

- 11.3.10 Deregistration shall only be performed by the subscription identified by the MSISDN number which is associated with the functional number. (M)
- 11.3.11 Deleted.
- 11.3.12 The result of the deregistration procedure shall be sent back to the mobile. In the event of a failure, an indication of the cause shall be provided. Information on the outcome shall be provided to the mobile according to [EN 301 515, Index [17]] and [EN 301 515, Index [34]]. (M)

Re-registration

- 11.3.13 Re-registration consists of a registration procedure followed by a deregistration procedure. (I)
- 11.3.14 Re-registration of on-train functional numbers based on the train number shall be performed every time a train leaves one EIRENE network and enters into another EIRENE network. (M)
- 11.3.15 Deregistration of a functional number shall not be carried out until registration of the functional number has been carried out and confirmed as being successful. (M)
- 11.3.16 Each railway should define a suitable time-out interval to be applied as part of the deregistration procedure for on-train functional numbers. (O)

Functional numbering network interworking

- 11.3.17 The exchange of information between EIRENE networks is handled by the GMSCs and shall use the standardised protocol as detailed in section 11.6. (M)

11.4 Re-establishment of functional number correlation

- 11.4.1 In the event of losing correlation between functional numbers and MSISDNs, provision for recovery from such a situation shall be made. (M)
- 11.4.2 Each national railway is responsible for implementing a suitable recovery mechanism and ensuring that the use of unverified functional numbers is prevented. (I)
- 11.4.3 Deleted.
- 11.4.4 Deleted.
- 11.4.5 Deleted.

11.5 Presentation of functional identities

- 11.5.1 The called party functional identity shall be presented to the user initiating a call and the calling party functional identity shall be presented to the user receiving a call. (M)
- 11.5.2 The calling party functional number shall be passed to the receiving mobile using the User to User Signalling supplementary service (UUS1) during call setup. (M)
- 11.5.3 If the calling party functional number is not available or if the calling party is not registered then the CLI of the calling party shall be displayed on the receiving mobile's display. (M)
- 11.5.4 The user-to-user information element in the SETUP, ALERT or CONNECT messages, as defined in [EN 301 515, Index [16]], shall be used to transfer the functional number of the calling party to the called party. (M)
- 11.5.5 The user-to-user information element shall use the following format: (M)

8	7	6	5	4	3	2	1	Octet	
User-User Information Element Identifier								1	Binary
Length of User-User contents								2	
User-User protocol discriminator								3	
0	0	0	0	0	0	0	0		
Tag defines presentation of Functional Identity								4	BCD
0	0	0	0	0	1	0	1		
Length of Numeric FN								5	
Numeric FN								6	BCD
Digit 2				Digit 1					
Digit m				Digit m-1				n	

- 11.5.6 If no valid functional number is available, a fixed length User-to-User Information Element shall be used with the following format: (M)

8	7	6	5	4	3	2	1	Octet	
								1	Binary
User-User Information Element Identifier									
Length of User-User contents								2	
0	0	0	0	0	0	1	1		
User-User protocol discriminator								3	
0	0	0	0	0	0	0	0		
Tag defines presentation of Functional Identity								4	
0	0	0	0	0	1	0	1		
Functional number								5	BCD
0	0	0	0	0	0	0	0		

11.5.7 Further information may be obtained from [MORANE PFN FFFS, MORANE PFN FIS]. (I)

11.6 Inter EIRENE network interfacing

11.6.1 Interconnection of EIRENE networks is required to allow international call routing. It is not envisaged that any routing database information is exchanged between EIRENE networks. (I)

11.6.2 The interconnection of EIRENE networks should take place by interconnecting GMSCs. (O)

11.6.3 The protocol used for routing of calls shall be Signalling System No 7 (SS7) as defined by the ITU-T. The signalling system suite shall include the Mobile Application Part (MAP). (M).

11.6.4 Call setup between EIRENE networks using international functional numbers shall be based on the combination of the Breakout-Code (BC) and International Code (IC) as specified in section 9. (M).

11.6.5 The Country Code (CC) followed by the National Significant Number NSN (as specified in ITU-T E.164, Chapter 6.2) shall be used as the Global Title, which forms part of the Signalling Connection Control Part (SCCP) protocol messages and is used for inter-network routing of messages. (M)

11.7 Location dependent addressing

General

11.7.1 Location dependent addressing may be provided in the following ways:

- a) cell dependent routing; (M)
- b) using location information from external sources. (O)

Cell dependent routing

- 11.7.2 As a minimum, call routing using location dependent addressing shall be based on the use of short codes in conjunction with cell dependent routing. (M)
- 11.7.3 Further information on cell dependent routing for location dependent addressing may be obtained from [MORANE SSRS] [MORANE LDA FFFS] [MORANE LDA FIS]. (I)

Location information from external sources

- 11.7.4 Location information may be provided by systems external to the radio system, for example ground-based systems such as track circuits. (I)
- 11.7.5 If a more accurate way of location determination is used, then position information shall be provided to the radio system which shall be used to associate the short code with the correct called party subscriber number. (M)
- 11.7.6 If implemented, the use of location information from train-based systems external to the radio system shall comply with the requirements stated in the enhanced Location Dependent Addressing FRS and IRS [eLDA FRS and eLDA IRS]. (M)

11.8 Calls from external networks to the EIRENE network

- 11.8.1 Facilities shall be provided to prevent unauthorised calls to mobiles either by functional number or MSISDN number from outside the EIRENE network. (M)

PAGE LEFT INTENTIONALLY BLANK

12 Text messaging

12.1 Introduction

12.1.1 There is no requirement for an internationally standardised pre-defined messaging application. However, it is anticipated that individual national railways may have a requirement for pre-defined messages, in which case the application will be specified as part of individual national procurements. (I)

12.2 System requirements

12.2.1 Where text messaging is implemented in the network, the Short Message Service (SMS) shall be used. (M)

PAGE LEFT INTENTIONALLY BLANK

13 Railway emergency calls

13.1 Introduction

- 13.1.1 This section covers the use of the EIRENE radio system for Railway emergency calls. The section also discusses the facility for confirmation of such emergency calls and the storage of confirmation for post-incident analysis. (I)
- 13.1.2 A Railway emergency call is a high priority call for informing drivers, controllers and other concerned personnel of a level of danger requiring all Railway movements in a pre-defined area to stop. Two types of Railway emergency calls are defined: (I)
- Train emergency calls (for Railway emergencies whilst not involved in Shunting operations);
 - Shunting emergency calls (for Railway emergencies whilst involved in Shunting operations).
- 13.1.3 This section describes the handling of high priority voice calls for Railway operational emergencies and does not cover public emergency calls (ie handling of '112' calls). (I)

13.2 Provision of Railway emergency calls

- 13.2.1 Railway emergency calls are defined as those calls of 'Railway emergency' priority (see section 10) which are routed to a pre-defined user or group of users due to a railway operational emergency. (I)
- 13.2.2 All Railway emergency calls shall be implemented using GSM VGCS (Specifications [EN 301 515, Index [21] & [4]]). (M)
- 13.2.3 It shall be possible to configure Railway emergency group call areas to contain combinations of cells controlled by one or more MSC(s) within one or more network(s). (M)
- 13.2.4 Where Railway emergency group call areas are controlled by more than one MSC within one or more network(s), a unique anchor MSC is defined for each group call area. (I)
- 13.2.5 For international Railway emergency calls, in order to minimise call set-up times, it is recommended that the anchor MSC always directly controls the cell where the Railway emergency call was originated. (I)

13.3 Initiation of Railway emergency calls

- 13.3.1 A Railway emergency call shall be initiated by using the appropriate function code for the required type of Railway emergency call (see Table 9-8). (M)

- 13.3.2 The call area and list of train controllers for each emergency group call will be fixed in the Group Call Register (GCR) of the anchor MSC. (I)
- 13.3.3 The Railway emergency group IDs required for interoperability are defined in section 9.5. The composition of each group is a matter for national implementation, although all areas shall have a group defined for all mandated Group IDs. (M)

13.4 Receipt of Railway emergency calls

- 13.4.1 Each mobile shall store a list of emergency Group IDs in the SIM appropriate to its function (the Cab radio will store Group ID 299 and 599 - see table 9-8). (M)
- 13.4.2 All Railway emergency group IDs required for interoperability and appropriate to the operation of the mobile shall maintain active status whilst the mobile is powered up. (M)
- 13.4.3 The fixed network user will only receive emergency voice calls if designated a dispatcher or group member in any of the calls defined in the GSM GCR. (I)
- 13.4.4 On receipt of a Railway emergency call, the controller's display should indicate the location of the train. (O)
- 13.4.5 If the requirement in 13.4.4 is implemented, as a minimum the location information shall be provided by the GSM network (eg current cell or base station serving the mobile). (M)
- 13.4.6 The mechanism for transferring the functional number of the originating mobile to controllers is defined in [EN 301 515, Index [6], Release 4] using the Information Element "Compressed OTDI" in the Immediate Setup 2 message from the originating mobile. (I)
- 13.4.7 If the GSM Release 99 capability and the Immediate Setup 2 feature defined in [EN 301 515, Index [6], Release 4] are supported by the network, the network shall set the MSC Release bit in the "Control Channel Description" information element to "1". Otherwise, the MSC Release bit in the "Control Channel Description" information element shall be set to "0" (zero) [EN 301 515, Index [41]]. (M)

13.5 Confirmation of Railway emergency calls

- 13.5.1 For post-incident analysis it is important that the initiation and receipt of Railway emergency calls by mobiles is confirmed by a message sent to a ground-based location (and also registered in the train borne recorder, in cases where a train borne recorder is connected to the Cab radio). (I)

- 13.5.2 Not all calls require confirmation. The application must be able to deduce that a confirmation is necessary from the call priority, as all calls of 'Railway emergency' priority must be confirmed. (M)
- 13.5.3 Confirmation of Railway emergency calls shall be implemented using the User to User Signalling supplementary service (UUS1). (M)
- 13.5.4 After clear down of the Railway Emergency call, the mobile application shall start the confirmation process by automatically originating a call. In order to avoid network congestion the call set up shall be delayed by a random offset. (M)
- 13.5.5 Railway Emergency call confirmation messages shall be of eMLPP priority 4 - "Railway information and all other calls" (see section 10.2). (M)
- 13.5.6 The user information contained in the confirmation message shall be: (M)
- Cab radio: the engine number or train number (if registered);
 - other mobiles: the user's functional number (if registered).
- 13.5.7 Confirmation messages shall be sent to a confirmation centre using a defined short code (see table 9-10), which shall be associated with the GSM network. (M)
- 13.5.8 In the case of Cab radio, details of the confirmation shall be passed to the train borne recorder if a train borne recorder is connected to the Cab radio. (M)
- 13.5.9 The user-to-user information elements in the following messages, as defined in [EN 301 515, Index [16]], shall be used for the confirmation of high priority calls: (M)
- SETUP: transfer of confirmation message to confirmation centre;
 - RELEASE COMPLETE: acknowledgement of the confirmation message.
- 13.5.10 The SETUP and RELEASE COMPLETE user-to-user information element shall be as specified in the [MORANE UUIE]. (M)
- 13.5.10i Confirmation centres shall be capable of decoding messages in either format A or B. (M)
- 13.5.11 Deleted.
- 13.5.12 Deleted.

PAGE LEFT INTENTIONALLY BLANK

14 Shunting mode

14.1 Introduction

- 14.1.1 The purpose of shunting mode is to provide an effective means of communication to a group of personnel who are involved with a shunting operation. (I)
- 14.1.2 The shunting group may comprise a shunting leader, a shunting driver, a controller and up to three additional personnel (the shunting members). (I)
- 14.1.3 Further information about shunting mode may be obtained from [MORANE SM FFFIS]. (I)

14.2 System requirements: Operational Radio

Enter shunting mode

- 14.2.1 On entering shunting mode, the operational radio shall determine if any shunting group ID is already activated on the SIM. (M)
- 14.2.2 If a shunting group ID is activated, the operational radio shall proceed to re-establish the group call. (M)
- 14.2.3 If no shunting group ID is activated, the operational radio shall initiate a “regular shunting mode ON” procedure as detailed in table 14-1. (M)

User Action	Application action
Select shunting mode. Dial area ID (5 digits)	Store area ID in non-volatile memory.
	Display selection list: – leader; – member; – exit (leave shunting mode).
	Activate group ID 500 (Common Shunting Group)*. Activate group ID 599 (Shunting Emergency)*. De-activate train emergency. Assign emergency button to shunting emergency number.
	Join the Common Shunting Group call (ID 500).

* “Activate group ID” means to activate voice group call reception on the mobile for these groups.

Table 14-1: Operational radio “regular shunting mode ON” procedure

14.2.4 After the “regular shunting mode ON” procedure has been completed, the procedures shown in table 14-2 and 14-3 shall be used to register the shunting leader and shunting members to a dedicated group call. (M)

User Action	Application action
Select <leader>. Enter shunting group number (2 digits). Enter number of shunting members.	Register functional number of shunting leader for the selected group number. Store group number and leader function code in non-volatile memory. Register spare numbers.
Tell shunting members to dial the group number and member number using the Common Shunting Group (ID 500).	
	Display selection list: – ID 500; – ID 5<Group number>; – exit (leave shunting mode).
Enter the appropriate group ID.	Activate the selected group ID and set up the dedicated group call.

Table 14-2: Operational radio dedicated group call registration procedure for the shunting leader

User Action	Application action
Select <member>.	Wait for information (via the Common Shunting Group) to determine which dedicated shunting Group to switch to.
Enter member number (1 digit). Enter shunting group number (2 digits).	Register to the related functional number. If unsuccessful, indicate this to the user and remain in the Common Shunting Group. Allow repetition.
	If successful, store the group number plus the member number in non-volatile memory. De-activate ID 500. Activate dedicated group ID and join the group call.

Table 14-3: Operational radio dedicated group call registration procedure for shunting members

Leave shunting mode

14.2.5 Two possibilities shall be available to the shunting leader when leaving shunting mode: (M)

- **Release group call:** the shunting leader and all other shunting members leave the dedicated group call and all members of the group are deregistered. The procedure that shall be used to release the group call is shown in table 14-4.

User Action	Application action
Inform all members to deregister their member functional numbers before releasing the call. Select <release>.	Release dedicated group call.
	Deactivate all active shunting group IDs excluding ID 599 (Shunting Emergency). Deregister as leader. Activate train emergency group ID. Assign emergency button to train emergency number. Deactivate shunting group ID 599 (Shunting Emergency).

Table 14-4: Operational radio shunting leader "Release group call" procedure

- **Maintain group call:** the shunting leader leaves the dedicated group call momentarily for the purposes of conducting other communications. The leader may then rejoin the group when ready. In the meantime, all other shunting team members remain active within the dedicated group call. The operational radio procedure that shall be used to maintain the group call is shown in table 14-5.

User Action	Application action
Select <maintain>.	Maintain dedicated group call.
	Deactivate all active shunting group IDs excluding ID 599 (Shunting Emergency). Activate train emergency group ID. Assign emergency button to train emergency number. Deactivate shunting group ID 599 (Shunting Emergency).

Table 14-5: Operational radio shunting leader "Maintain group call" procedure

14.2.6 On leaving shunting mode, the Operational radios of shunting members shall follow the procedure shown in table 14-6. (M)

User Action	Application action
Leave shunting mode.	Deactivate all active shunting group IDs excluding ID 599 (Shunting Emergency). Deregister as member. Activate train emergency Group ID. Assign emergency button to train emergency number. Deactivate shunting group ID 599 (Shunting Emergency).

Table 14-6: Operational radio shunting member "Leave shunting mode" procedure

14.3 System requirements: Cab radio

Enter shunting mode

- 14.3.1 On entering shunting mode, the Cab radio shall determine if any shunting group ID is already activated on the SIM. (M)
- 14.3.2 If a shunting group ID is activated, the Cab radio shall proceed to re-establish the group call. (M)
- 14.3.3 If no shunting group ID is activated, the Cab radio shall initiate a "regular shunting mode ON" procedure as shown in table 14-7. (M)

User Action	Application action
Select shunting mode. Dial area ID (5 digits).	Store area ID in non-volatile memory.
	Activate group ID 500 (Common Shunting Group). Activate group ID 599 (Shunting Emergency). De-activate train emergency and assign emergency button to shunting emergency number.
	Join the Common Shunting Group call (ID 500).
Wait for information (via Common Shunting Group) regarding which dedicated group call to switch to. Dial shunting group number (2 digits).	Register to the related Functional number. If unsuccessful, indicate this to the user and remain in the Common Shunting Group. Allow repetition.
	If successful, deactivate group ID 500. Activate dedicated group ID and join the group call.

Table 14-7: Cab radio "regular shunting mode ON" procedure

Leave shunting mode

14.3.4 The Cab radio shall exit shunting mode by means of the “Leave shunting mode” procedure as defined in table 14-8. (M)

User Action	Application action
Leave shunting mode	Deactivate all active shunting group IDs excluding ID 599 (Shunting Emergency). Deregister as driver. Activate train emergency group ID. Assign emergency button to train emergency number. Deactivate shunting group ID 599 (Shunting Emergency).

Table 14-8: Cab radio “Leave shunting mode” procedure

14.4 System requirements: Operational radio and Cab radio

- 14.4.1 On entering shunting mode, the terminal shall initially select the common shunting group. (M)
- 14.4.2 The common shunting group provides a point of contact for leaders and team members to set up a dedicated shunting group call for their shunting operation. (I)
- 14.4.3 The terminal application shall prevent members of a dedicated shunting team from initiating a new call (unless they are registered as shunting team leader and have left shunting mode using the “maintain group call” function described in 14.2.4). (M)
- 14.4.4 Deleted.

14.5 Numbering plan

- 14.5.1 The full numbering plan for shunting mode group calls is defined in subsection 9.9. (I)
- 14.5.2 Valid group IDs shall be as defined in table 14-9. (M)

Quantity	Name	Usage	Group ID
1	Common Shunting Group	Common initiation	500
20	Dedicated Shunting Group	Normal shunting	501-520
1	Emergency Shunting Group	Emergency (for the whole area)	599

Table 14-9: Valid Group IDs

14.6 Control of shunting group membership

14.6.1 Users shall be prevented from joining a dedicated shunting group by the EIRENE terminal application unless a valid functional number for the group has been successfully registered to the GSM-R network by their terminal. (M)

14.6.2 Deleted.

14.6.3 Deleted.

14.7 Link assurance signal

14.7.1 Deleted.

14.7.2 The link assurance tone shall be of the form specified in subsection 14.4.2 of the [EIRENE FRS]. (M)

14.7.3 The mechanism for the generation of the link assurance signal shall be as specified in [MORANE SM FFFIS]. (M)

14.7.4 Deleted.

14.7.5 The mechanism for the deactivation of the link assurance signal shall be as specified in [MORANE SM FFFIS]. (M)

15 Direct mode

15.1 Introduction

15.1.1 The operational requirement for direct mode is to: (I)

- 1) provide short range fall-back communications between train drivers and trackside personnel in the event of failure of all railway and/or public GSM services normally available;
- 2) provide short range communications for railway personnel operating in remote areas where no GSM facilities are available.

15.2 System requirements

15.2.1 Implementation of direct mode is optional. However, where implemented, the following requirements shall be mandatory. (I)

15.2.2 Frequency modulated equipment conforming to [ETS 300 086] shall be used for direct mode. (M)

15.2.3 Direct mode equipment shall have a maximum transmit power of 1 Watt. (M)

15.2.4 Direct mode equipment sensitivity shall be at least -107dBm . (M)

Frequency range and mode of operation

15.2.5 Direct mode equipment shall be capable of operation in the channels defined in table 15-1. (M)

Channel	Frequency
1	876.0125 MHz
2	876.0250 MHz
3	876.0375 MHz
4	876.0500 MHz
5	876.0625 MHz

Table 15-1: Direct mode channel frequencies according to [ECC(02)05]

15.2.6 Direct mode shall operate in simplex mode, a radio link that uses a single frequency for alternate transmission and reception. (M)

15.2.7 Voice transmission from direct mode equipment shall be possible only when the Push-To-Talk (PTT) button is pressed. (M)

CTCSS

- 15.2.8 Continuous Tone Coded Squelch Systems (CTCSS) shall be implemented on all direct mode equipment. (M)
- 15.2.9 The CTCSS tone shall be at a frequency of 203.5 Hz. (M)
- 15.2.10 The CTCSS modulation shall be within the limits defined in table 15-2. (M)

System	Angle
Channel Spacing kHz	Peak Deviation ± Hz
12.5	200 to 400

Table 15-2: CTCSS modulation limits

Direct mode common access channel

- 15.2.11 The purpose of the common access channel is to provide a point of contact and information for all direct mode users. For example, if one direct mode user wished to initiate contact with another user, communication would begin with a request for the desired partner on the access channel. After receiving a reply, both parties may transfer to a free direct mode channel and continue. (I)
- 15.2.12 Direct mode channel 1 (876.0125 MHz) shall serve as the common access channel. (M)
- 15.2.13 Equipment should default to operation on the common access channel (direct mode channel 1) on entry into direct mode. (O)

Direct mode interaction with GSM-R

- 15.2.14 Direct mode communications will only be used in the event of normal GSM-R services being unavailable. (I)
- 15.2.15 The presence of the GSM-R network shall be indicated to direct mode users. (M)
- 15.2.16 All terminals shall ensure that when GSM-R services are available, the user is prevented from entering direct mode. (M)
- 15.2.17 In the event of GSM-R causing disruption to ongoing direct mode communications, each railway will define a protocol for re-establishing contact by means of GSM-R. (I)

Shunting link assurance signal

- 15.2.18 All direct mode equipment shall provide the facility to broadcast an in-band audio shunting link assurance signal as defined in subsection 14.4.2 of the [EIRENE FRS]. (M)

A References

A.1 List of normative references

Specification	Title
EIRENE FRS	'UIC Project EIRENE Functional Requirements Specification', PSA167D005-7
MORANE EURO FFFIS	'Radio Transmission FFFIS for Euroradio', MORANE A 11 T 6001 12
MORANE ASCI OPTIONS	'ASCI Options for Interoperability', MORANE A 01 T 0004 1
MORANE CHPC FFFS	'FFFS for Confirmation of High Priority Calls', MORANE F 10 T 6002 3
MORANE CHPC FIS	'FIS for Confirmation of High Priority Calls', MORANE F 12 T 6002 3
MORANE FA FFFS	'FFFS for Functional Addressing', MORANE E 10 T 6001 3
MORANE FA FIS	'FIS for Functional Addressing', MORANE E 12 T 6001 4
MORANE LDA FFFS	'FFFS for Location Dependent Addressing', MORANE F 10 T6001 3
MORANE LDA FIS	'FIS for Location Dependent Addressing', MORANE F 12 T6001 2
MORANE PFN FFFS	FFFS for Presentation of Functional Numbers to Called and Calling Parties', MORANE F 10 T 6003 3
MORANE PFN FIS	'FIS for Presentation of Functional Numbers to Called and Calling Parties', MORANE F 12 T 6003 3
MORANE SIM	'FFFS for GSM-R SIM Cards'. MORANE P 38 T 9001 3
MORANE UUIE	'Specification on Usage of the UUIE in the GSM-R environment', MORANE H 22 T 0001 2

Specification	Title
EN 301 515	ETSI EN 301 515 v2.3.0, "Global System for Mobile Communication (GSM); Requirements for GSM operation on railways", Indexes [1] to [36] inclusive plus all of the changes identified in the ETSI TR 102 281, "Detailed requirements for GSM operation on railways". ETSI TR 102 281 v1.0.0 remains applicable until superseded by the formal publication of the first subsequent version currently identified as version 1.2.0.
EN 45001	'General criteria for the operation of testing laboratories'
EN 50081	'Electromagnetic compatibility – Generic emission standard'
EN 50140	'Radiated radio frequency electromagnetic field immunity tests'
EN 50153	'Railway applications – Rolling stock – Protective provisions relating to electrical hazards'
EN 60950	Safety of Information Technology equipment
EN 61000-4	'Electromagnetic compatibility (EMC) – testing and measurement techniques'
ENV 50121	'Railway applications – Electromagnetic compatibility'
ETS 300 086	'Radio Equipment and Systems, Land Mobile Service, Technical characteristics and test conditions for radio equipment with an internal or external RF connector intended primarily for analogue speech'
IEC 1508	'Functional safety: Safety related systems'
IEC 529/EN60529	'Specification for degrees of protection provided by enclosures (IP code)'
IEC 571	'Electronic equipment used on rail vehicles'
IEC 68	'Environmental testing'
IEC 721	'Classification of environmental conditions'
ISO 9001	'Quality systems – Model for quality assurance in design, development, production, installation and servicing'
prEN 50124	'Railway applications – Insulation co-ordination'
prEN 50125	'Railway applications – Environmental conditions for equipment'
prEN 50129	'Railway applications – Safety related electronic railway control and protection systems'
prEN 50155	'Railway applications – Electronic equipment used on rolling stock'
prEN 50261	'Railway applications – Mounting of electronic equipment'

A.2 List of informative references

Specification	Title
1999/569/EC	European Commission Decision 1999/569/EC "Commission Decision of 28 July 1999 on the basic parameters for the command-and-control and signalling subsystem relating to the trans-European high-speed rail system."
CEPT 25-09	CEPT Recommendation T/R 25-09 E (Chester 1990, revised at Budapest 1995), 'Designation of frequencies in the 900 MHz band for railway purposes'
ECC(02)05	Electronic Communications Committee of the CEPT ECC(02)05 "ECC Decision of 5 July 2002 on the designation and availability of frequency bands for railway purposes in the 876-880 and 921-925 MHz bands"
eLDA FRS	'enhanced Location Dependent Addressing Functional Requirements Specification', LDA_WG161, v4.0
eLDA IRS	'enhanced Location Dependent Addressing Interface Requirements Specification', LDA_WG162, v4.0
ERTMS COMMS	'Summary of ERTMS communications requirements', EEIG document number: 97E7377-v7, 31 July 1998
EN 301 515	ETSI EN 301 515 v2.3.0, "Global System for Mobile Communication (GSM); Requirements for GSM operation on railways", Indexes [37] to [50] inclusive.
ITU-T E.164	'The international public telecommunication numbering plan', May 1997
MORANE FFFIS MTI	'FFFIS for Mobile Terminal interface of the EIRENE Mobile Station', MORANE F 12 T 7003 2
MORANE SM FFFIS	'FFFIS for Shunting Mode', MORANE I 13/2 T 7001 2
MORANE SSRS	'Sub System Requirements Specification', MORANE A 04/22 T 6002 3
UIC 438-1	'Standard numerical marking of hauled passenger stock', UIC Fiche 438-1, 2nd edition, 1 January 1988, one amendment included.
UIC 438-3	'Identification marking for tractive stock', UIC Fiche 438-3, 1st edition, 1 January 1971, three amendments included.
UIC 558-1	'Remote control and data cable – Standard technical features for the equipping of RIC coaches', UIC Fiche 558, 1 st edition, 1 January 1996
UIC 568-3	'Loudspeaker and telephone systems in RIC coaches – Standard technical characteristics', UIC Fiche 568, 3 rd edition, 1 January 1996

Specification	Title
UIC 651	'Layout of cabs in locomotives, railcars, multiple units and driving trailers', UIC Fiche 651 (1 st Edition), January 1986